



DENTALAIRE

Meeting and Exceeding the Needs of Veterinary Dentistry since 1988
www.DentalAireProducts.com
800-866-6881

Find us on:
facebook.

Air Sourced Dental Stations

Portable Dental Stations

SilentAire Compressors

Hand Instruments

X-Ray Generators

Restorative Products

SilentAire Oil-Less Compressors

Digital Dental X-Ray Systems

Endodontic Equipment | Supplies

Consumable Supplies

Much More



Catalog Vol. XXX



DENTALAIRE



Dentalaire has been providing our clients with quality products since 1988. Our friendly and dedicated staff understands the needs of today's veterinary practice and are eager to help.

Our full line of products makes it easy to order and saves you time as well as money.

Good people, great service and quality products is what we're all about.

17150 Newhope Street, Suite 407 • Fountain Valley, CA 92708

1-800-866-6881

The Single Source for All Your Dental Needs

Limited Warranty

DENTALAIRE warrants its products to be free from defects in materials and workmanship only. No other warranties are expressed or implied.

Air Compressors & Portable Dental Units

All compressors and portable dental units including wall mounted and countertop dental units are warranted for one (1) year with the exception of the Prestige Dental station, which features an extended two year warranty. High Speed Turbines are warranted for six (6) months. High Speed & Low Speed Handpieces are warranted for one (1) year. Ultrasonic Scalers are warranted for two (2) years. Sonic Air Scaler Handpieces are warranted for one (1) year. True Seal prophy angles are warranted for (1) year with Economy angles warranted for 3 months, respectively. All other prophy angles and tips are not applied. Warranty is limited to repair, parts or replacement of item by Dentalaire. All other warranties are described in individual product description. Service replacement parts are warranted for 90 days.

The Corix X-Ray Generator, both mobile and wall mounted are warranted for one year for workmanship parts only. The DTX Digital Dental System is warranted for 2 years.

Instruments

All DENTALAIRE and Vetcare Dental Instruments are warranted for one (1) year. If any of our instruments break, chip or bend during any dental procedure, Dentalaire will replace the instrument at no charge. Defective item must be returned to us for exchange. Shipping is the responsibility of the customer.

ABOVE WARRANTIES ARE VOID IF ITEMS ARE CARELESSLY USED, IMPROPERLY INSTALLED, IMPROPERLY STERILIZED AND/OR MIS-USED. NO CLAIM FOR LABOR OR CONSEQUENTIAL DAMAGES WILL BE ALLOWED.

Any discrepancies in your order must be reported within 10 days of receipt of order.

Terms

Terms of payment will be established by results of credit report / references. Once credit terms are established, invoices will reflect terms extended by Dentalaire Products.

When placing your order please include purchase order number, product number, description and quantity. Also include shipping date required and preferred method of shipping.

Opened handpieces and equipment may not be returned for credit, but will be repaired or replaced in accordance with manufacturer warranties. Please inspect all packages carefully prior to opening.

Table of Contents

Instruments.....	3	Scaling Units.....	32
Instrument Kits.....	11	Micro Motor Units.....	33
Rodent Dental Instruments.....	13	Scaler / Micro Motor Combinations.....	34
Instrument Sharpening.....	15	Q & A on Dental Stations.....	34
Restorative Products.....	17	Equipment Comparison Chart.....	36
Endodontic Products.....	21	Dental Stations.....	37
Prophy Products.....	23	Compressors.....	43
Hand Pieces.....	27	Dental X-Ray Products.....	44
Burs, Scaling tips, Inserts.....	30	Miscellaneous.....	51

Hand Scaling Instruments

Hand Scaling Instruments include scalers and curettes and may be classified as being universal or area-specific instruments. Selections of these instruments are needed for cleaning teeth and treating periodontal pockets. **Scalers** have a triangular cross-section and a sharp tip on the end of the blade, and are designed to be used supragingivally (above the gum line). **Curettes** have a curved back and blunt toe on the end of the blade, making them safe to use subgingivally (under the gum line). Additionally, scalers and curettes may be further classified as being **universal** or **area-specific** instruments. When using universal instruments, both edges of the blade may be used. With area-specific instruments, only one edge of the blade may be used. The advantage of area-specific instruments is that they can be easier to fit to the root surface being cleaned.



Curettes

Curettes are used to remove subgingival calculus, root planing and for curettage (removal of disease in the soft tissue of the periodontal pocket). They have one blade with two cutting edges. Both cutting edges may be used on the front and back of the tooth.

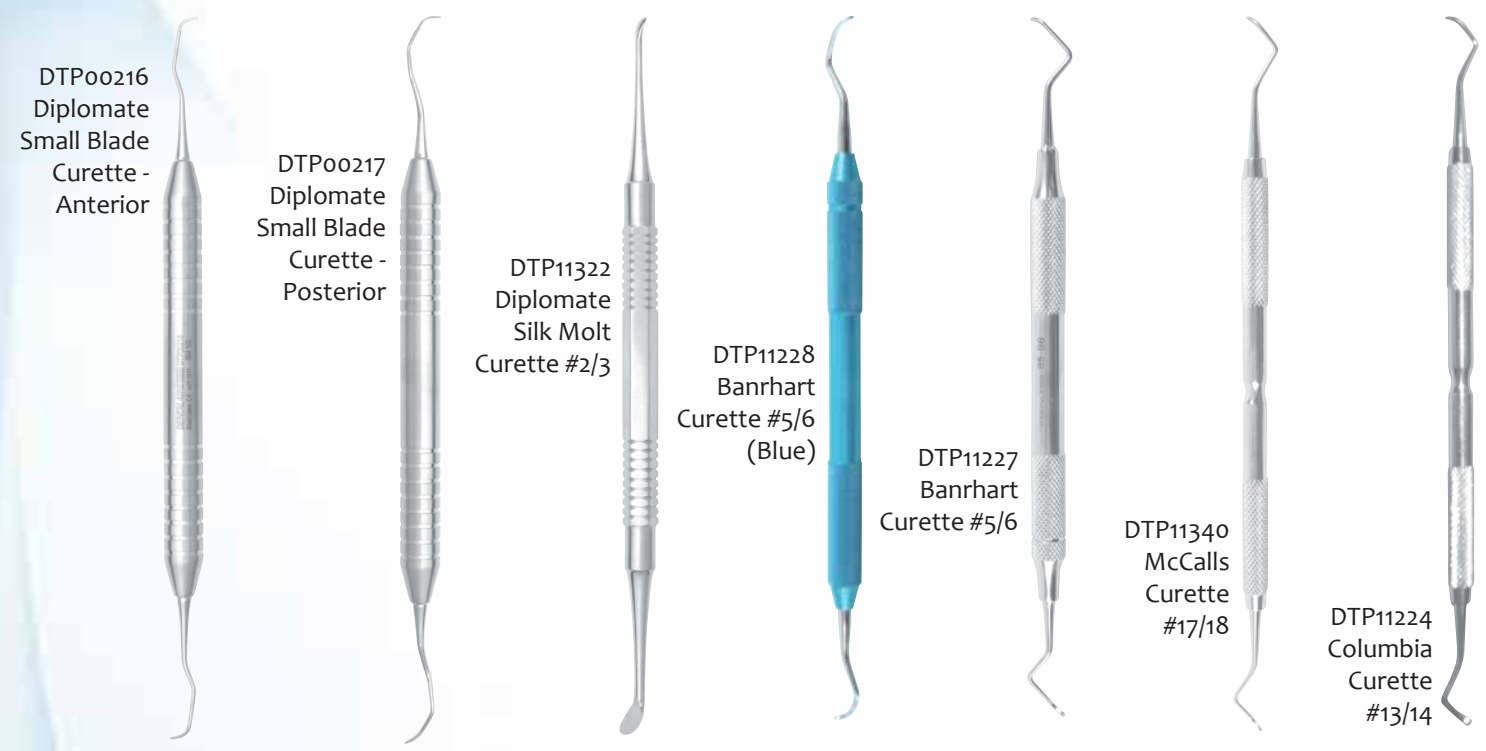

Gracey Curettes

Gracey Curettes have only one cutting edge with is designed for deep subgingival calculus, root planning and for curettage of the periodontal pocket.

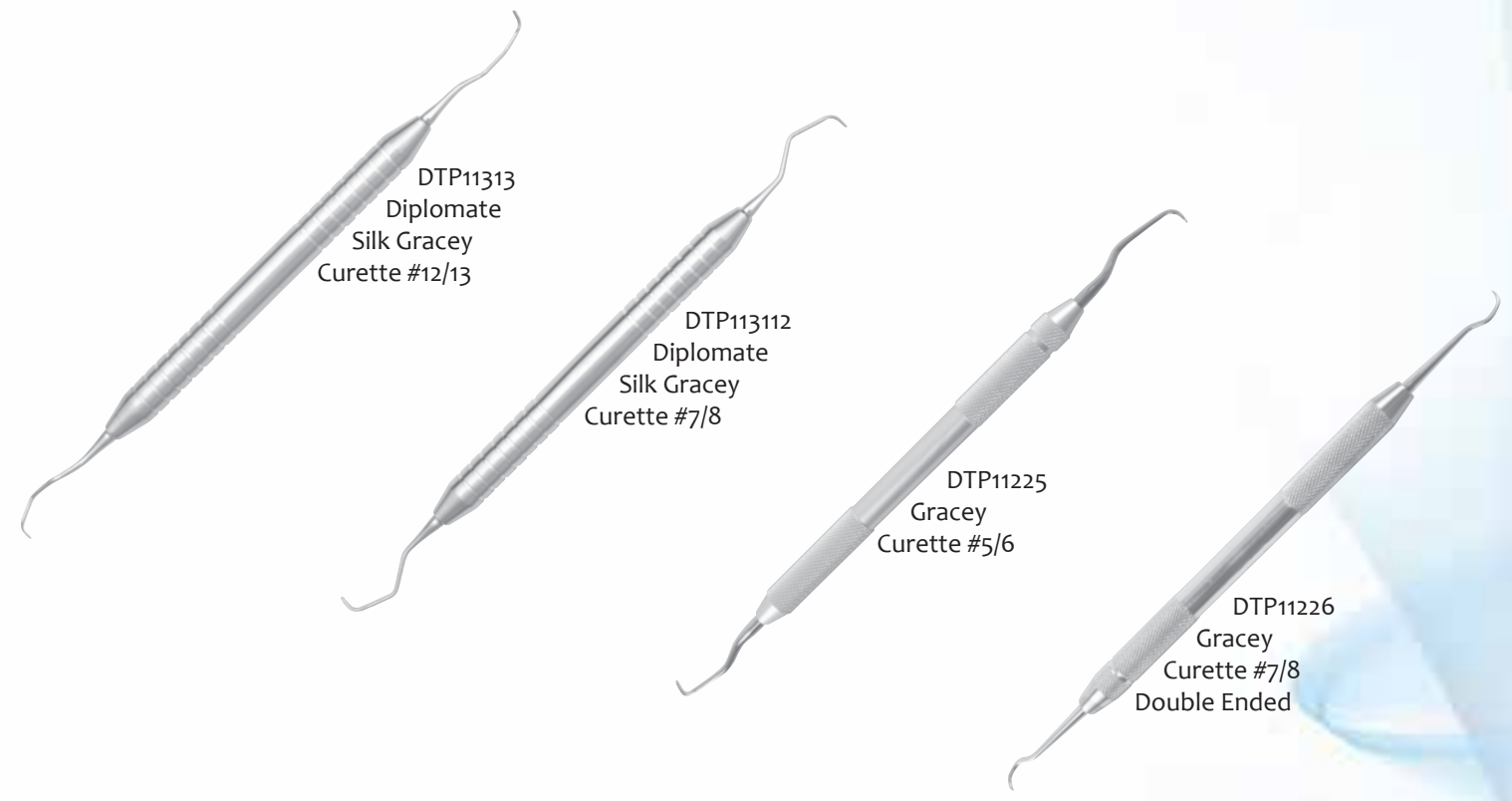

Probes and Explorers

Periodontal Probes and Explorers are detection instruments. The probe is used for measuring the depth of periodontal pockets. The explorer is used to detect calculus.



Winged Elevators

Winged elevators were designed by Dr. Robert Wiggs DVM, AVDC. These elevators are very popular and can make extractions easier in both dogs and cats. The unique semi-circular blade shape adapts well to the curved surfaces of roots, allowing the instruments to be inserted into the periodontal ligament space. When the inserted instrument is rotated, winged elevators generate exceptional leverage between the tooth and surrounding bone. These instruments also fit well into narrow interdental spaces between the teeth. Winged elevators come in four styles: Original S/S (light feel), Color Coded (Aluminum, heavier feel), Mini / Short Shanked, for smaller hands.

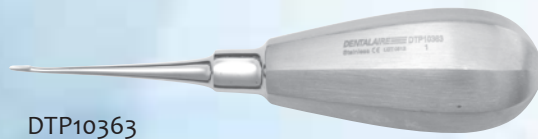

DTP10363
Diplomate Winged Elevator 1 mm

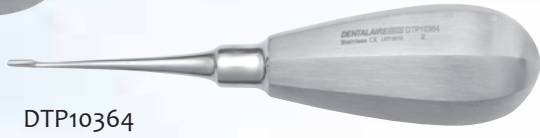

DTP10364
Diplomate Winged Elevator 2 mm

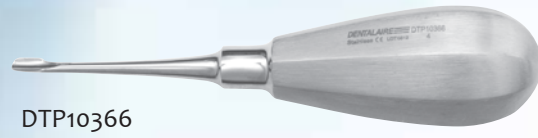

DTP10366
Diplomate Winged Elevator 4 mm



DTP10367
Diplomate Winged Elevator 5 mm



DTP10365
Diplomate Winged Elevator 3 mm



DTP10368
Diplomate Winged Elevator 6 mm



DTP10341 - #1 (1mm)
DTP10342 - #2 (2mm)
DTP10343 - #3 (3mm)
DTP10344 - #4 (4mm)
DTP10345 - Set of four w/case
DTP10328 - #6 (6mm)
DTP10329 - #8 (8mm)



DTP10356 - #1 (1mm) Mini
DTP10357 - #2 (2mm) Mini
DTP10358 - #3 (3mm) Mini
DTP10359 - #4 (4mm) Mini
DTP10360 - Set of four w/case



General Winged Elevator Description
 #1 - Used for feline and root tips
 #2 - Used for feline and small dogs
 #3 - Used for cat canine and dog teeth with medium sized roots
 #4 - Used for dog canine teeth and larger sized roots

Winged Elevators cont'd

DTPRX9001S - #1 Short Shank Winged Elevator
 DTPRX9002S - #2 Short Shank Winged Elevator
 DTPRX9003S - #3 Short Shank Winged Elevator
 DTPRX9004S - #4 Short Shank Winged Elevator
DTPRXSSET - Set of 4 USA made Short Shank Winged Elevators (pictured)



DTPRX9001L - #1 Winged Elevator
 DTPRX9002L - #2 Winged Elevator
 DTPRX9003L - #3 Winged Elevator
 DTPRX9004L - #4 Winged Elevator
 DTP00300 - Case only
DTPRXLSET - Set of 4 USA made Winged Elevators (not pictured)



DTP10347 - #1 (1mm) Violet



DTP10348 - #2 (2mm) Gold

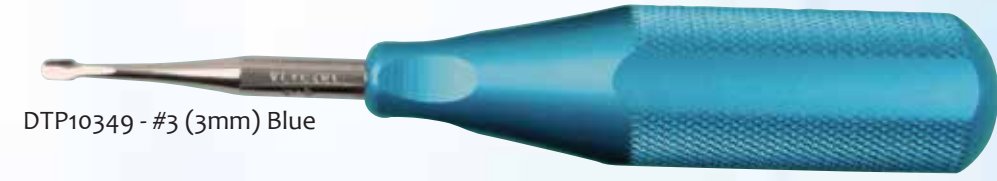

DTP10349 - #3 (3mm) Blue

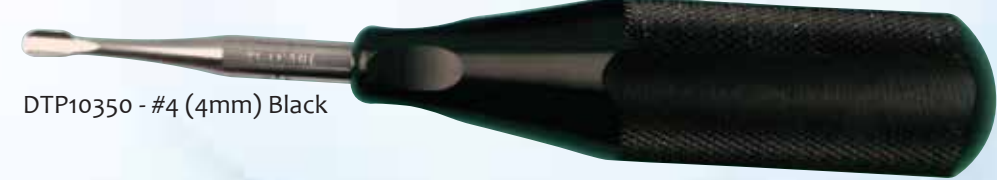

DTP10350 - #4 (4mm) Black

DTP10351 - Set of four w/case

Elevators

Straight Tip **Elevators** come with blades from 1mm-5mm wide which will cover all your needs except curved rooted teeth. SUPER SLIM tips are excellent for cats. MODIFIED TIPS are designed to guide it into the socket and cut the periodontal ligament. This prevents it from slipping out and causing damage to the gingival tissue. Makes elevation much easier.



Regular Tip



Modified Tip



DTP10331 - Feline Elevator - Super Slim



DTP10331SM - Feline Elevator w/V cut - Super Slim



DTP20331 - Canine Elevator

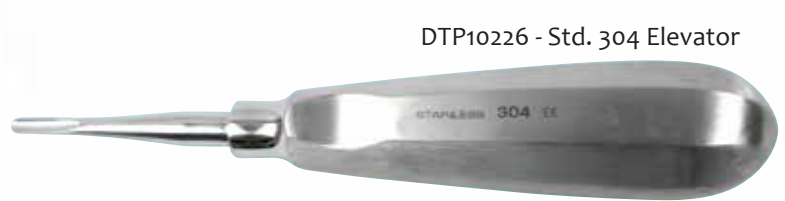

DTP10226 - Std. 304 Elevator



Serrated Elevators

These **Elevators** com highly recommended by Dr. Peter Emily. The serrations help to keep you from slipping or rolling off the root of the tooth. It does a great job in severing the peridontal ligament. It also helps grab the cementum of the tooth that is being sectioned.

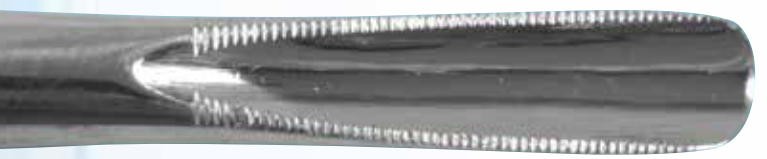

Comes in three convenient sizes:
DTP10338 - Feline Serrated Elevator - Small
DTP10340 - Mid-Sized Serrated Elevator - Medium
DTP20332 - Canine Serrated Elevator - Large

Luxators

Luxators are specially designed with sharp edges for easy insertion into the sulcular space used to sever the gingival attachment



DTP13101 - Diplamate Luxator Curved 1mm, Short Shank



DTP0730/1 - Luxator Straight 3mm



DTP13102 - Diplamate Luxator Curved 2mm, Short Shank



DTP0730/2 - Luxator Straight 5mm



DTP13103 - Diplamate Luxator Curved 3mm, Short Shank



DTP0730/3 - Luxator Bent Curve 3mm



DTP13104 - Diplamate Luxator Curved 5mm, Short Shank



DTP0730/4 - Luxator Bent Curve 5mm

DTP0730/5 - Luxators - Set of 4

Levitators

MODIFIED TIPS - The single ended feline and canine **levitators** have a "V" cut into the end of the instrument. This helps guide the tip into the socket, thus preventing it from slipping, causing damage to the gingiva.

CURVED INSTRUMENTS - Indispensible for extracting curved-root teeth (i.e. canine teeth and incisors). The curved tips are designed to follow the concave and convex curvatures of the teeth helping to prevent breaking the roots.



DTP00403 - Single Ended Canine (curved)
DTP00027 - Single Ended Canine (straight)

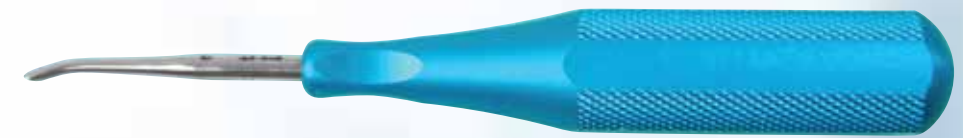

DTP00204 - Single Ended Feline (curved)
DTP00028 - Single Ended Feline (straight)

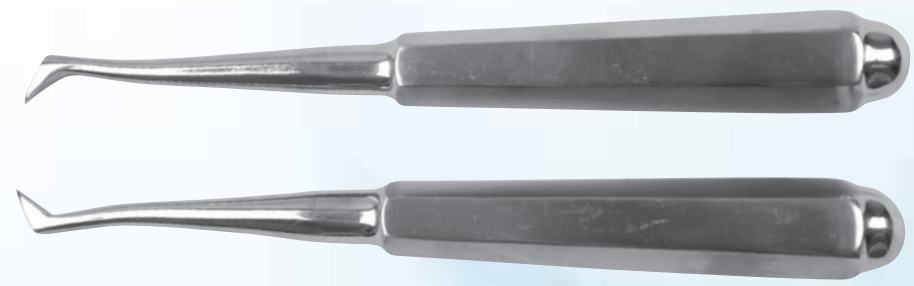

DTP10361 - Cryer Elevator #30
DTP10362 - Cryer Elevator #31

These elevators are helpful in removing the caudel teeth in dogs.

Periosteal Elevators

Periosteal Elevators are used to elevate the gingiva and mucosa away from the diseased pocket after an incision has been made with a scalpel on one or both sides of the pocket.

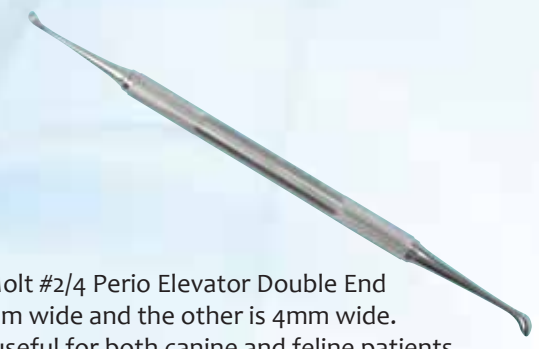

DTP10333 - Molt #2/4 Perio Elevator Double End
One end is 2mm wide and the other is 4mm wide. This instrument is useful for both canine and feline patients and is an excellent all-around tool for raising flaps. The ends have a slight curved shape, which keeps the instrument on the surface of the bone and helps prevent tearing of the flap as it is raised.

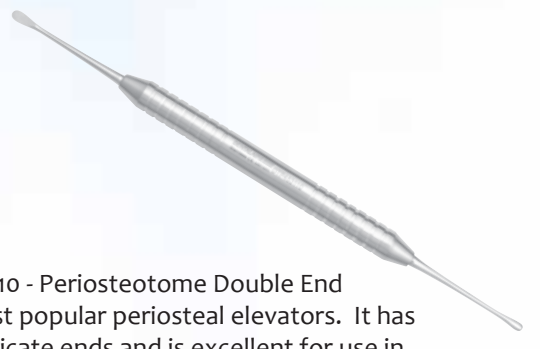

DTP453110 - Periosteotome Double End
One of our most popular periosteal elevators. It has small, very delicate ends and is excellent for use in doing gum flaps in small dogs and cats. Both ends are completely straight.



DTP10335
West #2
Perio Elevator
Double End



DTP10339
Molt #9
Perio Elevator
Double End



DTP10337
Freer #4
Small Perio
Elevator

Scissors

Scissors are useful in lengthening and trimming the gingival flap.



DTP20954 - Gum & Tissue "S"
Shaped Serrated Scissors (4 1/2")



DTP30960 - Serrated/Curved
Dean Scissors (7")



DTP30961 - Diplomate Dean Scissors

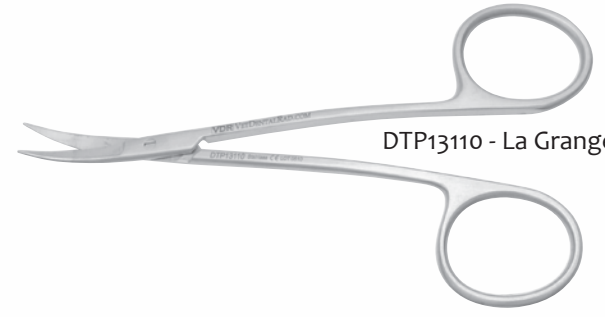

DTP13110 - La Grange Scissors

Extraction Forceps

Small **Extraction Forceps** are excellent for grasping small teeth (especially in cats). All have spring action for easy manipulation.

DTP10645S - Small Extracting Forceps (4 1/2")
Beak tips are flat and close completely. Perfect for small cats teeth.

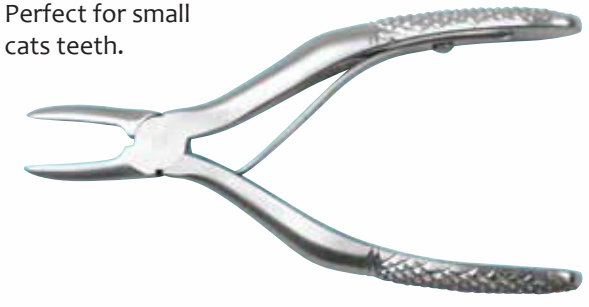

DTP20645 - Large Extracting Forceps (6 1/2")
Useful for large canine teeth, premolars and molars.

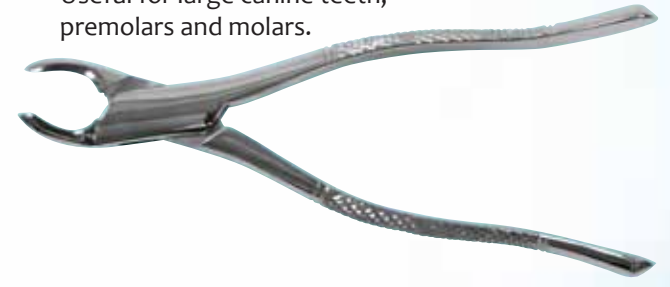

DTP20379 - Fragment Forceps - Angular (5")
Indispensable for broken root fragments and some small delicate teeth, such as incisors of cats.

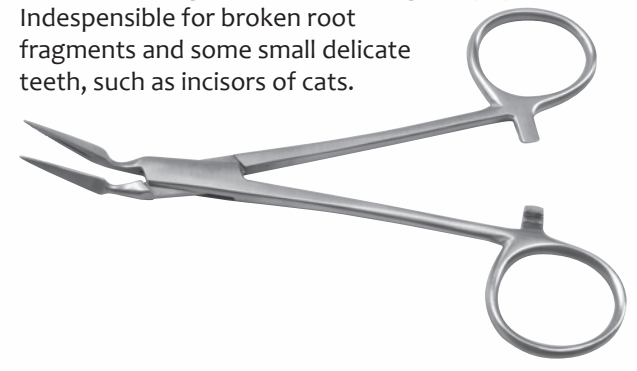

DTP13914 - Extraction Forceps with Right Angle (5 1/2")
Excellent for small incisors and caudal teeth.



DTP11305 - Tartar Remover Forceps - Small (4 1/2")
Designed to remove heavy deposits of calculus from the teeth.



DTP11307 - Tartar Remover Forceps - Large (5 1/2")
Designed to remove heavy deposits of calculus from the teeth.



*DTP10645 Curved Forceps (not pictured)

DTP10644 - Rongeur Forceps - Small (4 1/2")

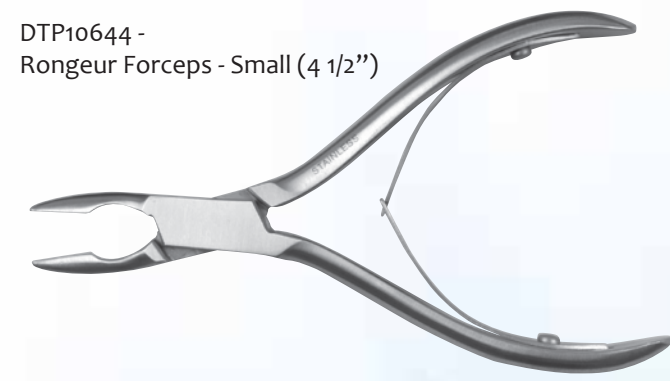

DTP20644 - Rongeur Forceps - Medium (5 1/2")

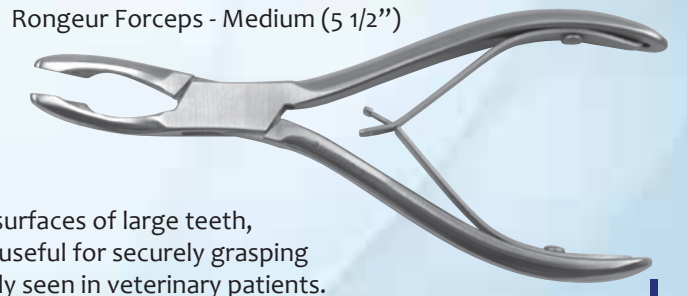

Useful for gently grasping flat surfaces of large teeth, such as canine, for extraction. Also useful for securely grasping the conical tooth fragments commonly seen in veterinary patients. Can also be used for trimming rough bone edges in the surgical site.

Diplomate Kits

DENTALAIRE is very pleased to bring you **Diplomate Approved Instrument Kits**. DENTALAIRE enlisted the expertise of Veterinary Dental Diplomates to assist us in developing these specialized instrument kits. High quality instruments are available in an autoclavable stainless steel cassette.

DIPLOMATE PERIO SURGERY KIT

DTP4-008122

Part#	Description	Qty
DTP00211	Excavator #31L	1
DTP00212	Excavator #33L	1
DTP00216	Small Blade Curette-anterior	1
DTP00217	Small Blade Curette-posterior	1
DTP11313	Silk Gracey Currette #12/13	1
DTP11312	Silk Gracey Currette #7/8	1
DTP11314	Silk Expro 23E/18P	1
DTP11315	Silk Jacquette Scaler #U15/33	1
DTP11316	Silk Mouth Mirror	1
DTP11320	Silk Morse Scaler #0-00	1
DTP11322	Silk Molt Currette #2/3	1
DTP11325	Needle Holder	1
DTP13107	Adson-brown Tissue Forcep	1
DTP13108	Scalpel Blade #3	1
DTP13110	La Grange Scissors	1
DTP453110	Periosteotome	1

(instruments are also sold separately)

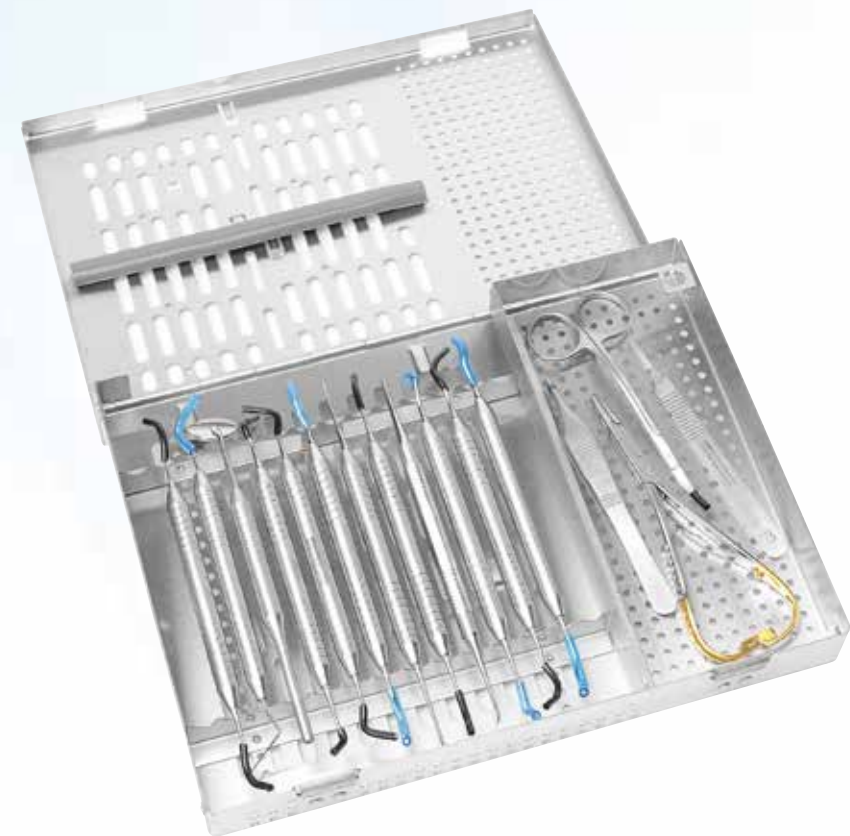

DIPLOMATE EXTRACTION KIT

DTP3-18814

Part#	Description	Qty
DTP10179	Woodward Heidbrink Root Tip	1
DTP10363	Diplomate Winged Elevator 1mm	1
DTP10364	Diplomate Winged Elevator 2mm	1
DTP10365	Diplomate Winged Elevator 3mm	1
DTP10366	Diplomate Winged Elevator 4mm	1
DTP10367	Diplomate Winged Elevator 5mm	1
DTP10368	Diplomate Winged Elevator 6mm	1
DTP10646	Diplomate Friedman Roneur 4.5	1
DTP11314	Silk Expro 23e/18p	1
DTP11322	Silk Molt Currette #2/3	1
DTP13103	Luxator Curved 3 mm	1
DTP13104	Luxator Curved 5 mm	1
DTP13107	Adson-brown Tissue Forcep	1
DTP13108	Scalpel Blade #3	1
DTP13109	Olsen-hegar Needle Holder	1
DTP30961	Diplomate Dean Scissors	1
DTP00212	Excavator #33L	1

(instruments are also sold separately)



Hand Instrument Kits

Understanding the purpose and use of hand instruments is basic to veterinary dental procedures. Each instrument is designed for a specific application from calculus removal to tooth extraction. The classification is determined by it's use.

WOODWARD EXTRACTION KIT - DTP10613

This extraction kit includes all the basic dental instruments required for extractions in dogs and cats. It was designed by Dr. Tony Woodward, DVM/AVDC from Colorado Springs, CO. "This kit has the instrumentation for almost all your extraction needs."

The kit contains the following items:

DTP10613 - One (set of 4) S/S Winged Elevators.

- 1mm - **DTP10341**, 2mm - **DTP10342**,
- 3mm - **DTP10343**, 4mm - **DTP10344**

These are sharp and have a fine edge to them. They have a unique spoon shape that hugs the tooth and gives you some added leverage by using it in a side to side twisting or rocking motion.

DTP0730/3 - 3mm Curved Luxator

DTP0730/4 - 5mm Curved Luxator

These elevators are useful in medium to large-sized teeth. Mostly used in dogs. These are sharp and have a fine edge to them and sometimes will fit where the winged elevators won't.

DTP30960 - One pair of 7" Curved Serrated Dean Scissors

These are helpful in lengthening and trimming the gingival flar as well as cutting sutures in the mouth.

DTP10333 - One Molt 2-4 Perio Elevator

This is a double-ended instrument used for elevating gingival flaps in dogs and cats.

DTP10644 - One Small Rongeur Forceps, 4.5"

Used as an extraction forceps and bone contouring tool.

DTP10175 - One Straight Root Tip Pick

Useful for removing fractured root tips below the gumline.



Special "Mini" Series for smaller animals. These hand instruments are ideal for feline dentistry, as well as for scaling the teeth of rodents. The shorter 3/4" shank allows for easier access to the mouth and gives you much better stability. This in turn will greatly reduce hand fatigue.

MINI-SHORT SHANKED HAND INSTRUMENT KIT with free instrument tray

DTP11287

Part#	Description	Qty
DTP11282	M5/6 Gracey #5/6	1
DTP11283	M2/3 Jacquette #2/3	1
DTP11284	M0/00 Morse #0/00	1
DTP11285	M6/7 Sickle Scaler H6/H7	1
DTP11286	M5/6 Barnhart #5/6	1
DTP11288	M15/16 Tartar Sickle/Chisle	1
DTP10925	Instrument Tray	



COLOR CODED INSTRUMENT KIT

DTP11330 - Set of 6 with Free Autoclavable Tray*

Part#	Description	Qty
DTP11225	Gracy 5/6 Curette	1
STP11228	Barnhart 5/6 Curette C/C	1
DTP11271	Feline Scaler	1
DTP11274	Morse Scaler C/C	1
DTP11276	H6/H7 Scaler	1
DTP11278	Tartar Scraper / Chisel C/C	1
DTP10925	Small Animal Instrument Tray	1



BASIC DENTAL INSTRUMENT SET-UP KIT

DTP10612 - Set of 6 with Free Autoclavable Tray*

Part#	Description	Qty
DTP10545	Mouth Mirror	1
DTP11227	5/6 Barnhart Curette Eco	1
DTP11275	H6/H7 Scaler Eco	1
DTP11279	Tartar Remover Scraper	1
DTP11390	Probe / Explorer 1/23	1
DTP11226	Gracey Curette 7/8 Eco	1
DTP10925	Small Animal Instrument Tray	1



*Autoclave up to 250 degrees only on tray

Miscellaneous Instruments

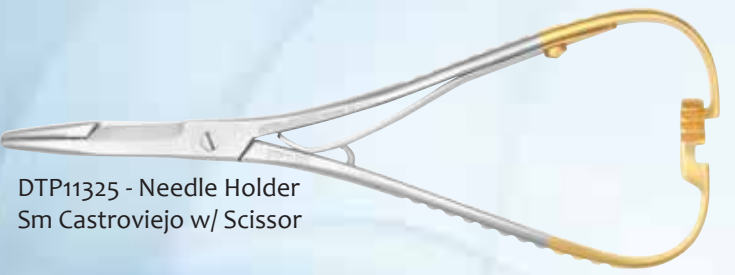

DTP11325 - Needle Holder Sm Castroviejo w/ Scissor

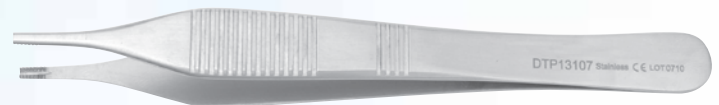

DTP13107 - Adson-Brown tissue Forceps



DTP00211 - Diplomate Excavator #31L



DTP00212 - Diplomate Excavator #33L Luxators

Indispensable for removing small pieces of broken root tips.



DTP10175 - Root Tip Pick #78 (Straight)



DTP10176 - Root Tip Pick #79 (Left Angle)



DTP10177 - Root Tip Pick #80 (Right Angle)

DTP10178 - Root Tip Pick (Set of 3)

Single Ended Bone Curettes



DTP10352 - Molt #1



DTP10353 - Molt #2



DTP10354 - Molt #4

Rodent Dental Instruments

Designed especially for your Rodent Patients.



DTP02443 - Rodent Bur Guard
A soft tissue protector used on low speed handpieces.



DTP454700 - Rabbit Incisor Luxator

Rodent Dental Instruments

Designed especially for your Rodent Patients.

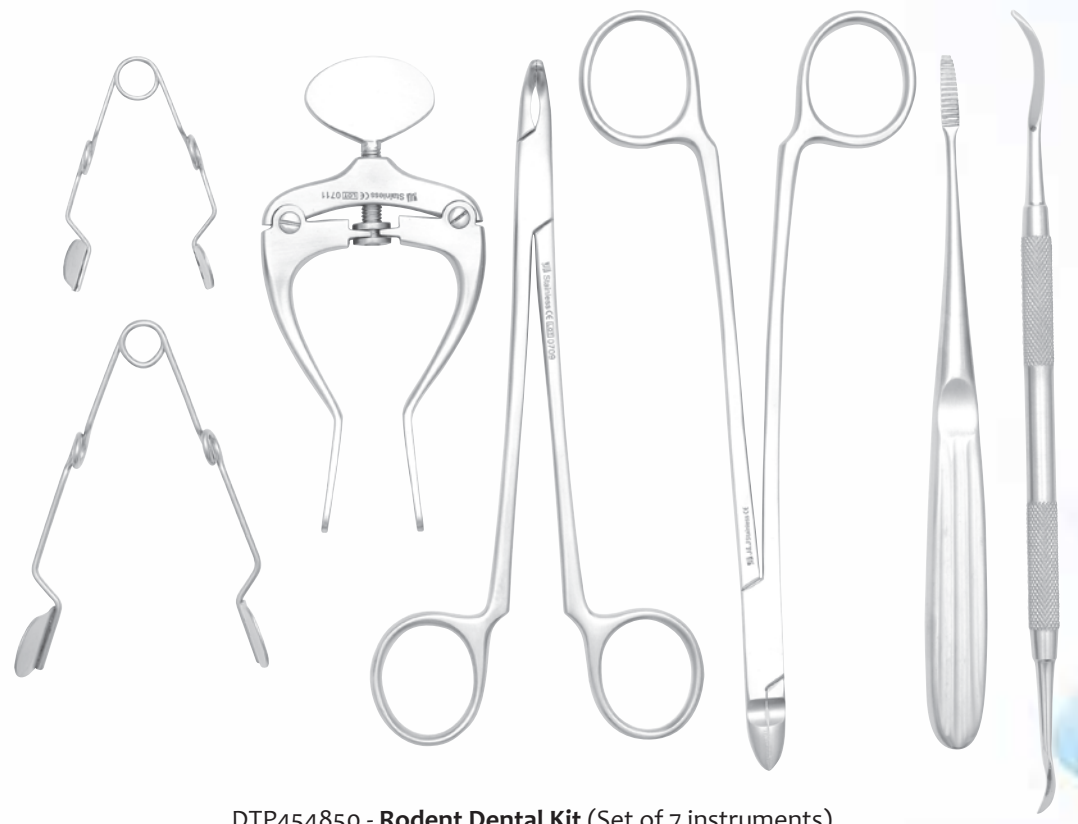

DTP454850 - Rodent Dental Kit (Set of 7 instruments)
(Instruments included below plus DTP454700 Rabbit incisor Luxator, page 13)

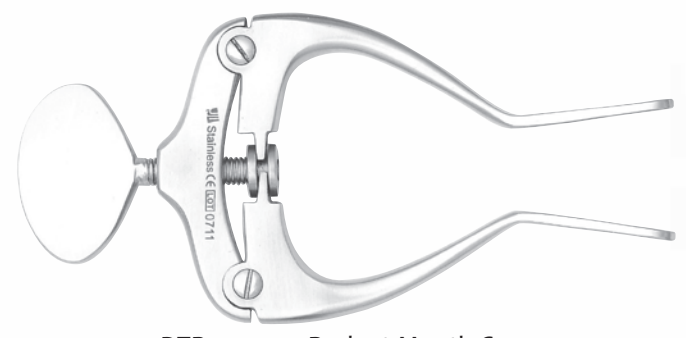

DTP454500 - Rodent Mouth Gag
An essential tool when examining the mouth of a rabbit.

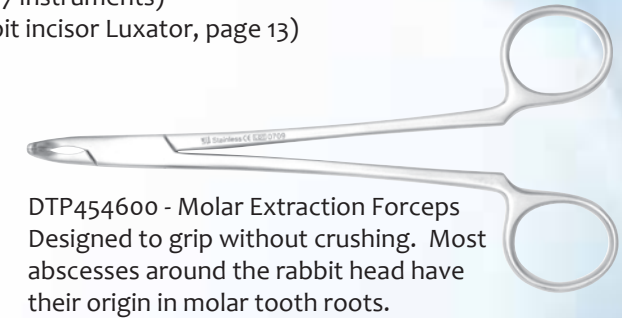

DTP454600 - Molar Extraction Forceps
Designed to grip without crushing. Most abscesses around the rabbit head have their origin in molar tooth roots.

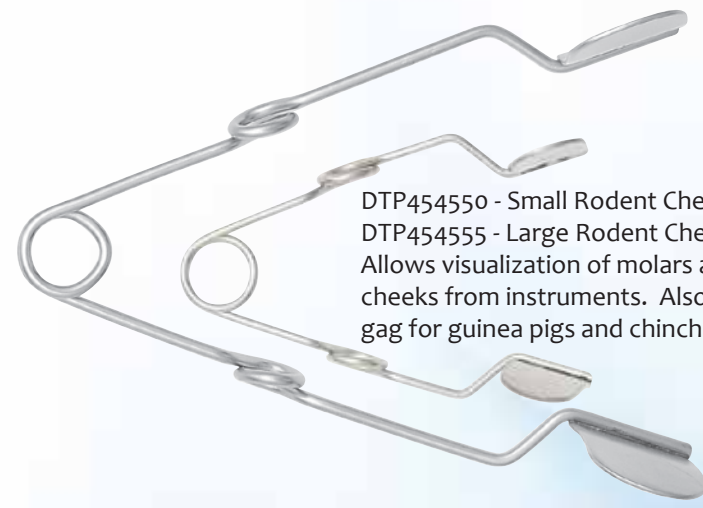

DTP454550 - Small Rodent Cheek Dilator
DTP454555 - Large Rodent Cheek Dilator
Allows visualization of molars and protects cheeks from instruments. Also useful as a gag for guinea pigs and chinchillas.

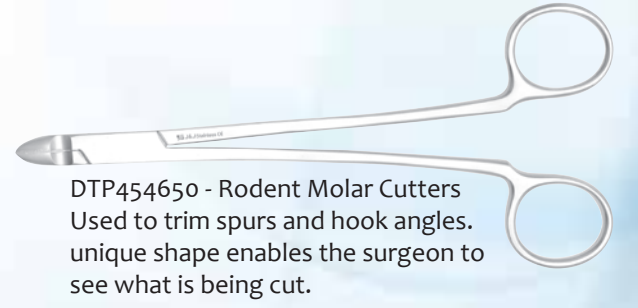

DTP454650 - Rodent Molar Cutters
Used to trim spurs and hook angles. unique shape enables the surgeon to see what is being cut.



DTP454800 - Molar Rasp
Used to remove tooth spurs without damaging the delicate root structure.

Instrument Trays

Organize your instruments on these autoclavable trays.



DTP10925L - Large Instrument Tray (Flat)
Autoclavable - 13 1/2" x 9 5/8"



DTP10925D - Large Instrument Tray (Divided)
Autoclavable - 13 1/2" x 9 5/8"

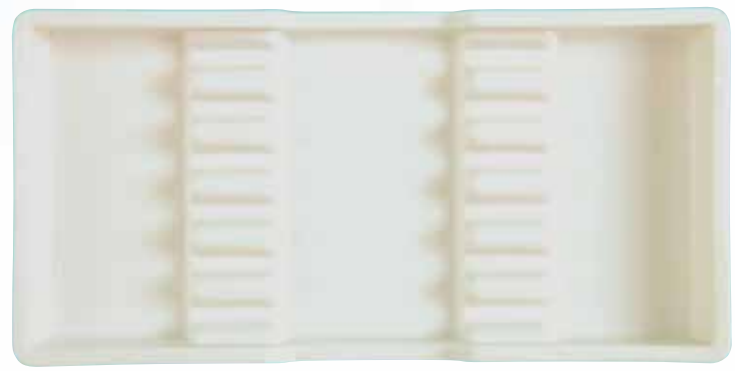

DTP10925 - Small Instrument Tray (Divided)
Autoclavable - 8" x 4"

A01-115 - Stainless Steel Tray
13 1/2" x 9 5/8"
(not pictured)

Sharpening Stones

DTP10616K - **Sharpening Stone Kit**, contains conical and flat stones, acrylic test stick and lubricating oil.



DTP10615 - Arkansas Sharpering Stone, Conical
3" (base) x 5/16"



DTP10375 - Arkansas Sharpering Stone, Flat
4" x 1" x 1/4"

DTP10660 -
Lubricating
Oil, 4 oz.



Instrument Sharpening

Maintain and restore your instruments to like new condition. Sharpens all surgical instruments.



DTP90602 - RX Sharpening System II
3 Year Warranty, Made in U.S.A.

The only sharpening system designed to maintain and restore instruments to like new condition. Save time and money on your surgeries. Sharp instruments make your job easier. This machine will properly sharpen; Elevators, Curettes, Scissors, Olsen Hegar Needle Holders, Orthopedic Instruments and much more. Most instruments can be sharpened in 2 minutes or less. Used in dental practices, hospitals and in veterinary clinics for over 30 years. You can't afford not to have it. Give it a try! You'll be glad you did.



DTP90601 - RX Honing Work Station
The Rx Workstation is ideal for up-close work. The workstation includes a stand with lamp and 2/4 power magnifier. The lamp and magnifier are mounted on 18" flex arms and can swivel and be placed in multiple positions.



DTP90603 - RX Honing Shaft
Heavy duty shaft provides pencil control in the honing of intricately shaped cutting edges.

An insight on using bonded sealants... Smoothing a fracture site and applying bonded resin sealants serves several purposes. Smoothing the fracture site decreases plaque adherence and calculus accumulation and decreases soft tissue irritation from the fracture surface. Plugging the dentin tubules with the bonded sealants decreases sensitivity and helps prevent infection of the pulp chamber. After the application of bonded sealants, the tooth is able to provide a permanent “patch” on the inside through the deposition of reparative dentin. Typically, this procedure is only done once per fracture site.

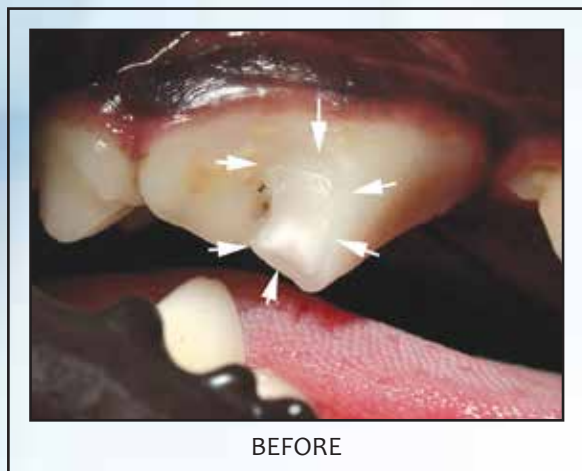

BEFORE

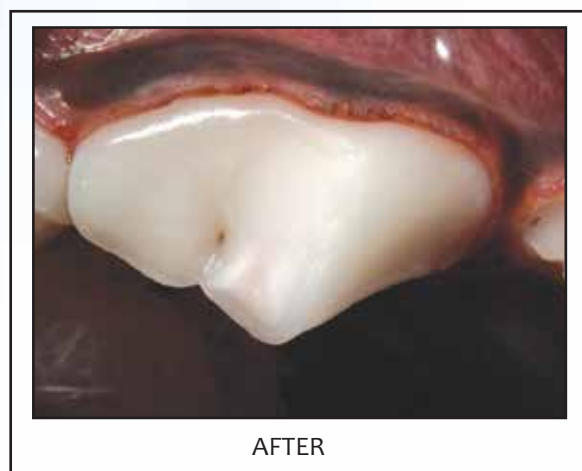

AFTER

DTP99950 - Bonded Sealant Kit

This kit has all you will need to start applying bonded sealants for exposed vital dentin and bonding composite restorations. The kit comes complete including instructions. It contains the following items: (treats 30-44 teeth)

1. Etch 37% Phosphoric Acid (5mg syringe), is used to etch dentin and enamel prior to restorative materials.
2. One Step, which is a universal light cure dental adhesive.
3. Fortify is a “unified resin” used for coating area of sealed dentin and composite restorations.
4. Super Snap Mini Kit is designed for easy, fast and safe contouring, finishing and polishing of fractured teeth and composites.
5. Disposable Mixing Wells (48), these are ideal for handling and applying dental materials dispensed in small quantities.
6. Disposable Applicators (Light blue - 100), ideal for precise application of dental materials.
7. Dura-White Stones (2), for use in high speed handpiece.
8. Contra Angle

DTP99950 Kit contains:

- DTP5503E - Etch 37%
- DTP1102P - One Step Adhesive
- DTP9031F - Fortify Sealant
- DTP22491 - Super Snap Mini Kit
- DTP80496 - Disposable Mixing Wells
- DTP80241 - Disposable Applicators (Orange, 100)
- DTP0450 - Dura-White Stones (2)
- DTP553UL - Latch Type Contra Angle



DTP99955 - Contains all of the above plus curing light

DTP99956 - Level 2 Restorative Kit

Includes all items from Bonded Sealant Kit, Curing Lite plus/ (1) DTP671A2 Flowable composite, (1) DTP814A2 general purpose composite and DTP00210 Woodson PFI #3 Plastic Filling Instrument.



Litex 695 LED Curing Light - DTP00802

- Thin and lightweight dual intensity light polymerization LED curing light
- Standard autoclavable 8.5mm probe with 360° rotation for easy access
- No more bulbs to replace with average LED life of 50,000 hours
- Smooth and contoured ergonomic design offers added comfort and easy cleaning
- Conveniently located thumb buttons set timer and intensity for two stage step-curing
- Two-stage polymerization resulting in less shrinkage stress
- Automatic timer with audible tone and digital display on handpiece
- Curing cycle can be interrupted manually with one-touch trigger button
- Large Lithium battery capacity provides 750 ten-second curing cycles on a full charge
- Low battery warning beeper
- Built-in light intensity indicator
- Eye protection shield included for safe operation



Litex 696 Cordless LED Curing Light - DTP00803

- Power supply: 100V to 240V
- Thin and lightweight dual intensity light polymerization LED Curing Light
- Standard autoclavable 8.5mm probe with 360° rotation for easy access
- LED life ~ 50,000 hours
- Choice of ramp, pulse or regular curing modes: Bright light intensity of 1200 mW/cm²
- Automatic timers with audible tone and digital display on handpiece
- Curing cycle can be interrupted manually with one-touch trigger button
- Large Lithium battery capacity provides 750 ten-second curing cycles on a full charge
- Eye protection shield included for safe operation



Clear Blue Curing Light - DTP00683

This light is very portable, never heats up (LED), is quiet and very easy to read. No bulbs are needed.



ONE YEAR WARRANTY

Technical Specifications:

- Power Supply: 100V to 240V
- Weight: 80gm
- Light Source: Super Blue LED
- Spectrum Range: 450-490nm
- **DTP00689** - Light Guide: 8mm angled optical fibers
- Standard Accessories:
 - 1 light guide (8mm) DTP00689, 1 handpiece and 1 handpiece holder
 - 1 oval protector, 2 mini-protectors



Super-Snap® Polishing System - DTP24490

Designed for easy, fast and safe contouring, finishing and polishing of all micro filled and hybrid composites. The ultra-thin disks are very flexible, bending under pressure without breaking and allowing easier access to interproximal areas. You will find the complete range of disks in the Super-Snap Rainbow Technique Kit. The kit contains 180 disks (100 standard, 80 mini), 40 polustrips, 2 Dura-White Stones (shapes CN1 and FL2), 1 Composite Fine, Mid-Point and 4 CA mandrels - all presented in a semicircular rainbow organizer tray.



Super-Snap® Mini Kit - DTP24491

DTP0450 Pack of 5 DURA White Stones (not pictured)

Discs sold individually:

- DTPS230747 - Black Mini Replacement Disc - PK of 50
- DTPS230805 - Green Mini Replacement Disc - PK of 50
- DTPS230815 - Red Mini Replacement Disc - PK of 50
- DTPS230820 - Violet Mini Replacement Disc - PK of 50

Restorative Dental Products

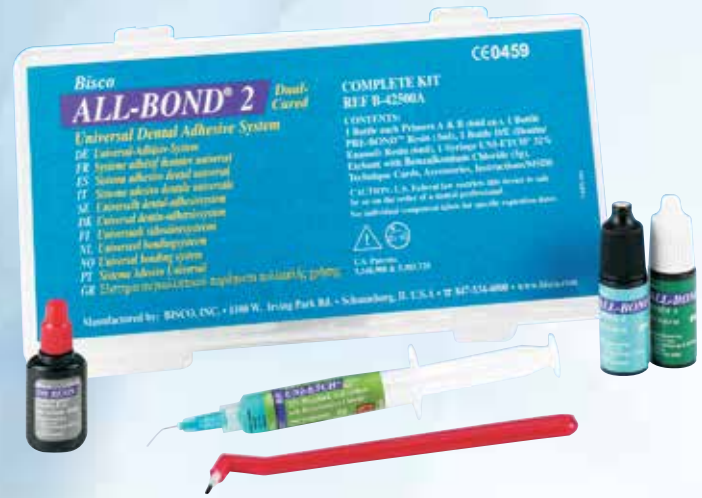

All-Bond 2 (6ml x 2)
DTP42500 - All Bond 2 w/Etch, DE Resin, Prebond Kit
DTP2510A - All Bond 2 (Refill) 5g x 2
 This is a universal dental adhesive, which is still unsurpassed in its ability to bond to dentin, enamel, new or old composites and amalgams. It has dual-cured primer, which means it can be used with or without a light cure unit. It also comes with an antimicrobial etchant that etches and disinfects at the same time.



All-Bond 3 (6ml x 2) - DTP2510A
 All-Bond 3 is a dual-cured, 3-step universal dental adhesive system that is compatible with all dental materials. It utilizes improved All-Bond 2 technology making All-Bond 3 relatively more hydrophobic to enhance the durability of the bond. The ethanol-based formula requires less number of coats and is more user friendly than All Bond 2. All-Bond 3 Resin is a hydrophobic radiopaque filled bonding resin. It's radiopacity outlines the restoration and reduces the risk of misdiagnosing caries. All-Bond 3 Resin is HEMA-Free, which makes the bonding layer less prone to water sorption. Water sorption can be a critical cause of degradation of the bond and may promote further decay.

- Easier and faster to use
- More hydrophobic for longer lasting bonds
- Consistent and predictable results

DTP5501E - All-Etch 10%, 5mg syringe
 DTP5363E - All-Etch 10%, 70gm



Fortify (5ml) - DTP9031F
 Composite Surface Sealant Refill
 This is an "unfilled resin" used for sealing of composite restorations. It fills microscopic defects and improves the longevity of composite restorations. It also helps to prevent micro leakage. This product is also very useful for sealing exposed dentin in fractures, when used in combination with One-Step (light cure) or All-Bond (self cure) dental adhesives.



Etch 37% - DTP5503E
 (Phosphoric Acid) 5gm Syringes used to etch dentin and enamel prior to placing restorative materials. (most popular)

Etch 37% - DTP5638E
 (Phosphoric Acid) 70gm

Blue Tips for Acid Etch - DTP5503F (bags of 30)



One-Step (6ml) - DTP1102P
 This is a universal light cure dental adhesive, which bonds to a wide variety of dental substrates. Very useful in sealing exposed dentin tubules in fractured teeth.



One-Step Plus (6ml) - DTP2001P
 This is a "filled version" of the clinically proven One-Step. It is designed to bond to composite dentin, enamel, cast materials, treated porcelain and set amalgam. A very strong bonding agent for composite restoratives.



DTP10860 - Pumice, Fine Grit, 8oz.

Restorative Dental Products

Brush Tips/Handles
DTP80223 - Brush Tips, pack of 1000
 Ideal for applying adhesives, activators, sealants and other liquids. (not pictured)

DTP80211 - Brush Handle is ideal for reaching any tooth surface and holds the above brush tips.



Cement Spatula - DTP10212

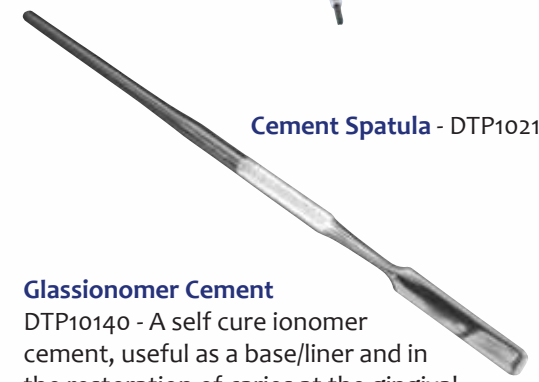

Glassionomer Cement
DTP10140 - A self cure ionomer cement, useful as a base/liner and in the restoration of caries at the gingival margin. (not pictured)



Vitrebond Glass Ionomer Liner/Base
DTP24492 - Vitrebond is a dual-cure (both light and self-cure) glass ionomer useful as base/liner, in endodontic restorations, and in the restoration of caries at the gingival margin. Fluoride release aids in preventing the extension of carious lesions.



DTP10575 - Visible Light Cure Calcium Hydroxide Liner
 Used as a liner in cases of near pulp exposure, vital pulp therapy after placement of calcium hydroxide powder on the exposed pulp tissues. Light cure polymerization is very convenient and shortens clinical procedure times.

Mixing Wells - packs of 48
DTP80496 - These are ideal for adhesives, opaquers and all materials dispensed in small quantities.



Applicators - packs of 100
DTP80241 - Applicator (disposable) Regular/Orange
 For applying adhesives in large areas.

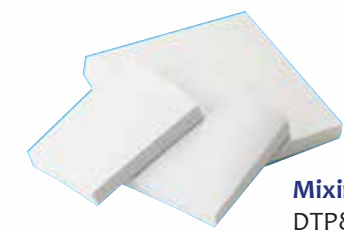
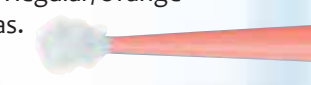

Mixing Pads - 2-3/8" x 2-3/8", 5 pads per pack
DTP80485 - Great to use with Vitrebond.

Brush Applicator - Dark Blue
DTP80247 - These Endo Brushes are used when applying adhesives to a prepared canal, prior to cementation of a post.



Aeliteflo Composite (Light Cure/Flowable)
 This is easily injected into restoration sites. Benefits include radiopacity for easy identification, easily polished, very stain resistant, excellent wear resistance and strength. Used mainly for filling defects in non-occlusal areas.



DTP671A2 - Shade A-2, refill 1.5gm. Syringe, Light Cure/Flowable
DTP671A3 - Shade A-3, refill 1.5gm. Syringe, Light Cure/Flowable
DTP673C2 - Shade C-2, refill 1.5gm. Syringe, Light Cure/Flowable
DTP674D3 - Shade D-3, refill 1.5gm. Syringe, Light Cure/Flowable
DTP67500 - Aeliteflo Intro Kit Contains;
 1.5gm Syringes: A1, A2, A3.5, C2 and D3, disposable syringe tips, instructions / MSDS

Restorative Dental Products

Aelite (Light Cure/Micro Hybrid) Composite
 This is a very durable composite, which is ideal for all applications. Excellent for use in ALL CLASS of restorations. It offers you superior handling and resists slumping, which gives you greater control. It can be used as a core build up material or all alone by itself. This composite is polishable to an enamel like finish, while offering a high resistance to wear and stain. It can be used in high force areas of occlusion.



- DTP814A2 - Aelite All Purpose Body Composite (Shade A-2)
- DTP814A3 - Aelite All Purpose Body Composite (Shade A-3)
- DTP814C2 - Aelite All Purpose Body Composite (Shade C-2)
- DTP814D3 - Aelite All Purpose Body Composite (Shade D-3)

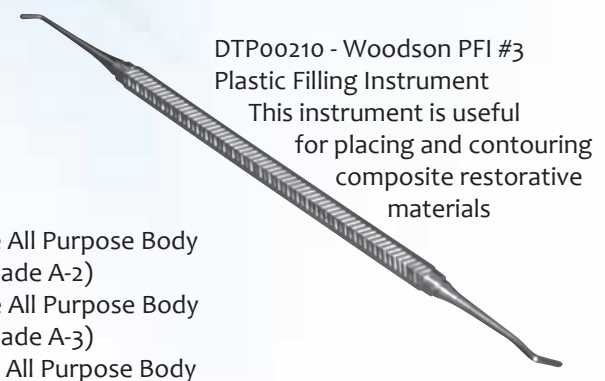

DTP00210 - Woodson PFI #3 Plastic Filling Instrument
 This instrument is useful for placing and contouring composite restorative materials

All 4 of these products come in a .25gm syringe

Endodontic Products

Endodontic Organizers
 DTP103301 - Gutta Percha Millimeter marked, ml. 029 240 pts., #15/80



DTP301203 - Paper Points Millimeter marked as MMPP 240pts., #15/80



DTP10230 - Zinc Oxide 1.5oz, Powder



DTP10153 - Eugenol Liquid

Impression Products

DTP10125 - Alginate Powder



DTP10213 - Alginate Spatula



DTP150110 - Flexi-Bowl Green, 700ml



DTP00966 - Impression Tray Set of 8

K-Reamers

- Set of 3 assorted (60mm)
- DTP01777 - #15-20-25
- DTP01778 - #30-35-40
- DTP01779 - #45-50-55
- DTP01780 - #60-70-80

DTP10570 - Endo Locking Pliers Useful for handling paper point and gutta percha points.



H-Files

- Set of 3 assorted (60mm)
- DTP01747 - #15-20-25
- DTP01748 - #30-35-40
- DTP01749 - #45-50-55
- DTP01750 - #60-70-80



H-Files

- Set of 3 assorted (120mm)
- DTP01761 - #20-25-30
- DTP01762 - #35-40-45
- DTP01763 - #60-70-80



Endodontic Products

Diplomate Pluggers - DTP00020 - Diplomate Plugger Kit - Contains all of the below instruments. These endodontic/composite pluggers are designed for multiple applications including compaction of gutta percha (when heated), placement of composite restoratives, placement of medicaments when performing vital pulp therapy (pulp caps), and placement of apical endodontic restorations. The four sizes, each with two unique bends, will cover most of your plugger needs.



- Diplomate Pluggers**
- DTP00016 - Diplomate Plugger A - .03mm
 - DTP00017 - Diplomate Plugger B - .04mm
 - DTP00018 - Diplomate Plugger C - .05mm
 - DTP00019 - Diplomate Plugger D - .06mm

Absorbent Paper Points (not shown)

- 60mm Paper Points (60)
- DTP218291 - #15, 20, 25
- DTP218292 - #30, 35, 40
- DTP218293 - #45, 50, 55
- DTP218294 - #60, 70, 80
- DTP218295 - #90
- DTP218296 - #100
- DTP218297 - #110
- DTP218298 - #120
- DTP218299 - #130
- DTP218300 - #140

Gutta Percha (not shown)

- 60mm Gutta Percha (60)
- DTP122203 - #15
- DTP122204 - #20
- DTP122205 - #25
- DTP122206 - #30
- DTP122207 - #35
- DTP122208 - #40
- DTP122209 - #45
- DTP122210 - #50
- DTP122211 - #55
- DTP122212 - #60
- DTP122213 - #70
- DTP122214 - #80
- DTP122215 - #90
- DTP122216 - #100
- DTP122217 - #110
- DTP122218 - #120
- DTP122219 - #130
- DTP122220 - #140

Holstrom Plugger/Spreaders

- Special veterinary pluggers and spreaders designed by a veterinary dentist, Dr. Steve Holstrom.
- 35mm long, sizes #50, 65 & 90
- 28mm long, sizes #20 & 35
- Especially useful for obstructions in larger canine teeth.
- Available individually or in a set.

- DTP453120 - Holstrom Plugger/Spreader #20
- DTP453135 - Holstrom Plugger/Spreader #35
- DTP453150 - Holstrom Plugger/Spreader #50
- DTP453165 - Holstrom Plugger/Spreader #65
- DTP453190 - Holstrom Plugger/Spreader #90
- DTP453191 - Holstrom Plugger/Spreader Set of 5

- DTP190662 - Finger Pluggers
 Set of 6 Assorted, 25mm, Color Coded
- Used to vertically condense gutta percha in root canal procedures.
 - 25mm long, sizes #15-40
 - Available individually or in a set x/tray



- DTP190676 - Finger Spreaders
 Set of 6 Assorted, 25mm, Color Coded
- Used for laterally spreading gutta percha in root canal procedures.
 - 25mm long, sizes #15-40



Prophy Products



DTP00729 - VETCARE Propy Paste, Coarse Mint Flavor, 9 oz.

DTP00730 - VETCARE Propy Paste, Medium Fruit Flavor, 9 oz.

DTP00735 - Propy Paste Finger Ring Cup Stainless Steel



Fluoride Quick-Gel (Stannous Fluoride .4%) Helps Prevent cavities by strengthening the enamel. Also has anti-bacterial effect. 4.3 oz. bottle

DTP10524 - Berry
DTP10526 - Mint



DTP00731 - Individual Propy Paste Cups Fruit Flavor, Package of 100 Med.

DTP00720 - Snap-on Propy Cup, box of 144 (not pictured)
DTP00670 - Screw-on Propy Cup, box of 144 (pictured)
DTP00665 - Latch type Propy Cup, box of 144 (not pictured)

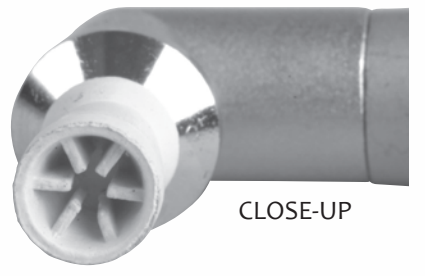

CLOSE-UP

DTP10525 - Fluoride Gel Concentrate Orange Vanilla Gel Concentrate - 16 oz. bottle
Active ingredient: 1.23% fluoride ion.



DTP10521 - Fluoride Foam Strawberry - 7.4 oz. bottle
Active ingredient: 1.23% fluoride ion.



DA100CS - Oraldent Cleansing Solution 0.1% Chlorhexidine solution - 8 oz. bottle



DTP10695 - Disclosing Solution, 2 oz. Used to locate calculus or plaque on teeth. Good to spot check thoroughness of prophylaxis. Paint on with Q-tip or brush.



Prophy Products



DA10955 - TRUE-SEAL Propy Angle Sealed & Autoclavable, Snap-on

DA551PSN - ECONOMY Propy Angle Autoclavable, Snap-on

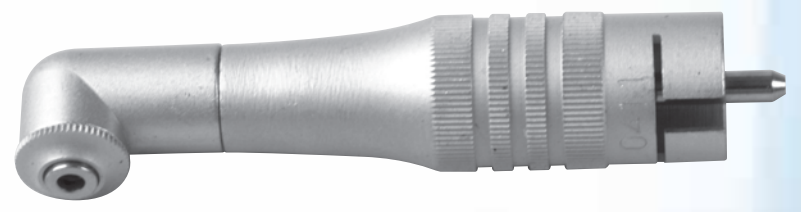

DA10956 - TRUE-SEAL Propy Angle Sealed & Autoclavable, Screw-on

DA552PSC - ECONOMY Propy Angle Autoclavable, Screw-on



DAEH-20PK Snap type contra head only, 20 pk (Shown)

DAEH-20L Latch type contra head only 20 pk (not pictured)



DTP10966 - Sparkle Disposable Propy Angle Soft, Bag of 100

DTP00735 - Propy Paste Ring Cup

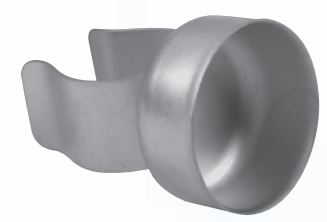

DTP10967 - Twister Propy Angle w/Cup, Bag of 100
DTP10967-50 - Bag of 50
DTP10965 - Standard Disposable Propy Angle w/Cup, Box of 144

Prophy Cup reciprocates back and forth. No paste splatter! No heat! No more tangles from catching hairs! Lates free.



DTP10970 - Sparkle Disposable Contra Propy Angle Firm, Bag of 100

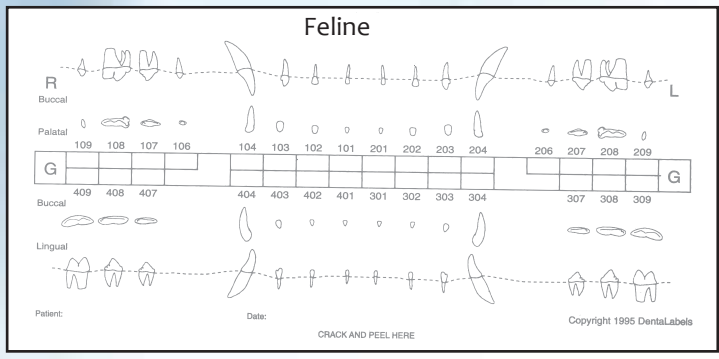
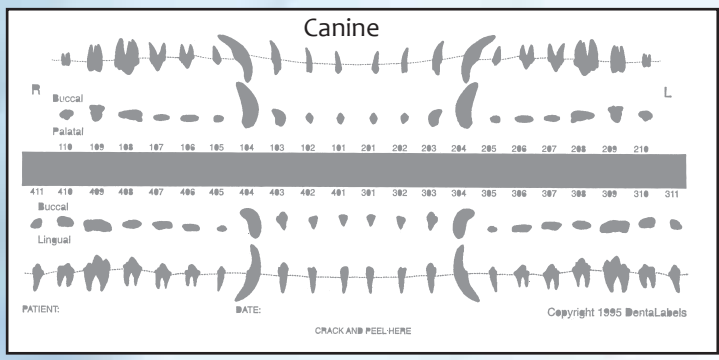

DTP20340 – Starter Kit - 25 Canine / 25 Feline
 DTP20341 – Canine Refill - 50
 DTP20342 – Feline Refill - 50



Plastic Cheek Retractors
 Ideal for pulling back the lip corners of dogs for access to the caudal part of the mouth
 DTP42257 - Small, 1 1/2" wide - Feline
 DTP32590 - Large, 2" wide - Canine

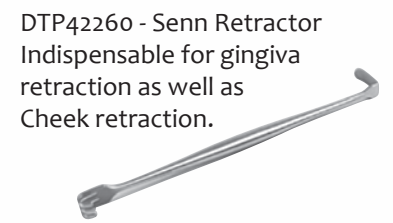

DTP42260 - Senn Retractor
 Indispensable for gingiva retraction as well as Cheek retraction.



DTP42251 - Dental Mouth Props
 3 sizes, Assorted
 Red, Yellow & Blue
 Perfect mouth prop for use during digital dental imaging procedures



DTP42254 - Large Mouth Gag, 7"
 DTP42250 - Canine Mouth Gag, 5"
 DTP42256 - Feline Mouth Gag, 3"
 Do not autoclave



DTP42258 - Atraumatic Lip Retractor
 Developed by a Veterinary dentist, gentle and flexible. The ends of the instrument are plastic coated to cushion the soft tissues and the flexible jaws may be gently bent to accommodate different lip thicknesses.



DTP360005 - Safety Glasses, Clear

Dentalaire Protection Gel with CHG
 The Gel that stays in place for > 24 hours!

Dentalaire Protection is an oral gel that contains 0.12 chlorhexidine gluconate. Dentalaire Protection is not a flush or rinse, but a gel designed especially for animals, is easy to work with and "stays where you put it." Dentalaire Protection Gel is packaged in easy to use single dose units for optimizing sterility for every patient.



Directions: Following anesthetic induction and endotracheal tube placement apply 1-1/2 cc of Dentalaire Protection to a gloved finger and rub the gel onto the tooth surfaces aiming for the gingival margin. This procedure can again be performed at the conclusion of the dental procedure prior to extubation. The gel stays in place for 24 – 48 hours!



In addition to the buccal surfaces, the gel can also be applied to the lingual surfaces. Most oral bacteria will be killed within the first 30 seconds, but some bacteria will require a longer time period. This is why we recommend allowing the gel to remain in contact with the oral cavity for a full 3 minutes. Dentalaire Protection Gel can also be dispensed for owners to administer at home when an easy to use chlorhexidine product is desired.



DTP11234 - Splash Shield
 Package of 3, comes with band
 Provides protection from paste splatter and bacteria.

Handpiece Parts & Accessories

DA400RCA - Push button replacement turbine with cap
DA100-CAPTOOL - Cap Tool
DANSK-A100 - Cap Only
DANSK-A485 - Turbine Only
Made in the U.S.A.



DA400FOB - Fiberoptic Bulb



DA310BT - Handpiece Bur Changer

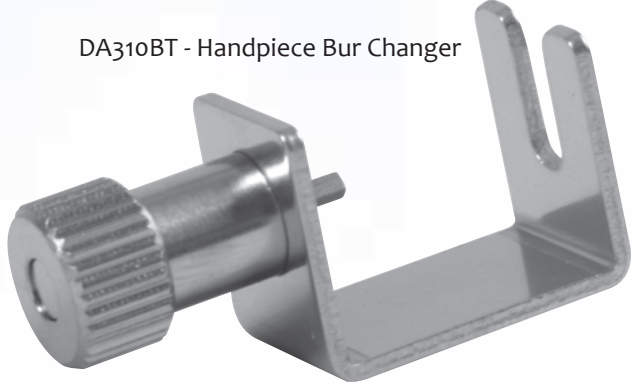

DA400RC - Standard Replacement Cartridge
DA400CP - Cap Only
Made in the U.S.A.

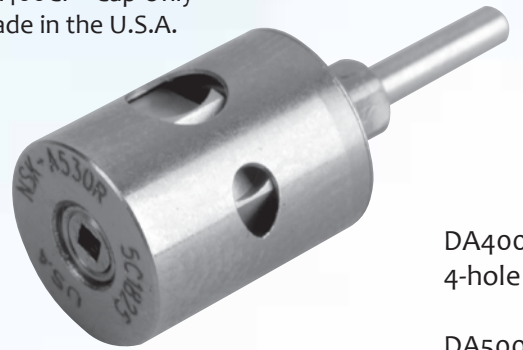

DA400GAS - Gasket for 4-hole handpieces

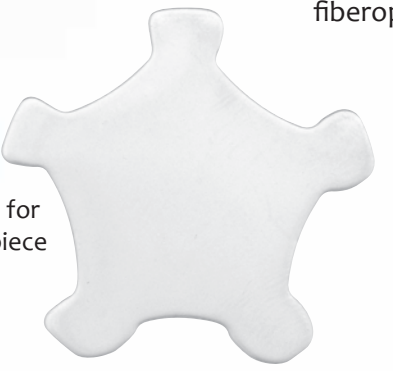

DA500GAS - Gasket for fiberoptic handpiece



DA100 - CapTool for push button High Speed Hand Piece



DTPLED-CPT - Cap Tool for LED High Speed Hand piece



DA2500EM - E-Type Motor, 20,000 RPM



DA2500SNC - E-Type Straight-nose cone, 20,000 RPM



DA400CH - High Speed Replacement Chuck for standard turbine
Made in the U.S.A.

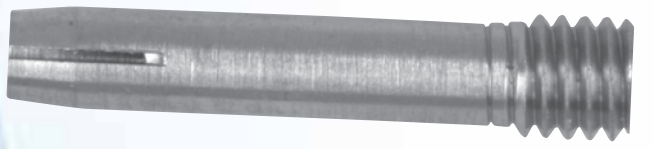

DA2500ECA - E-Type Conta-Angle, Latch



Handpiece Parts & Accessories

DA557FG - Contra Angle Attachment, Friction Grip

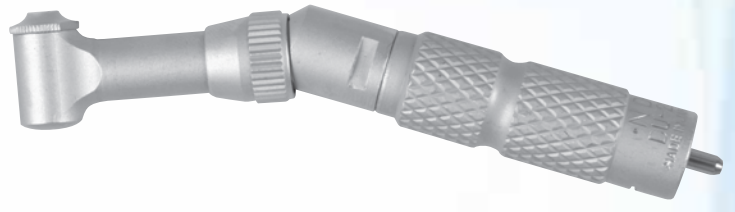

DA553UL - Contra Angle Attachment, Latch Type



High Speed Handpieces



DA400APB - High Speed Handpiece with push button
Made in the U.S.A.

DA400A - Standard High Speed Handpiece
Made in the U.S.A.



DA400AFOPB - Fiber Optic Push Button Handpiece
Made in the U.S.A.

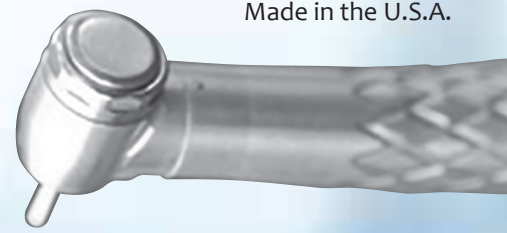

DA400LED - LED High Speed Handpiece
Retrofit any air powered dental station with LED lighting.
Built in generator, no fiber optic light source needed.



DA400 LG TURB - Replacement turbine for DA400LED

DA400SLS - Push button fiber optic swivel handpiece
(not pictured) Made in the U.S.A.



DA400AFOPB - Push Button High Speed Fiber Optic Handpiece
Made in the U.S.A.

Low Speed Handpieces

DA600HA - Low Speed Handpiece Hygienist, 5000 RPM with push/pull chuck system



DA600A - Low Speed, Light Weight, Standard Handpiece, 5000 RPM with opening & closing chuck system and reverse.



DA700A - Low Speed, Light Weight, Lube Free Handpiece, 5000RPM



DAMLS13793 - Nose cone only

Sonic Scaler Handpiece

DA7000AS - Sonic Air Scaler Handpiece
Sonic Air Scaler with 3 tips



Bur Blocks

DTP10201 - Bur Block

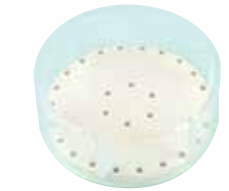

DTP10204 - Magnetic, Holds 28 Burs

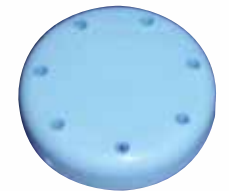

DTP10205 - Magnetic, Holds 7 Burs

Burs

Diamond Burs have a variety of uses, including crown preparation, shaping composite restorations, preparing sites for restorative materials and smoothing bone in surgical sites prior to closure. One advantage is that they do not tend to catch and tear the soft tissues as do most other burs. The flat end cylinder burs are particularly useful for smoothing bone. A selection of grits allows for progressive refinement of the area you are working on. Diamond burs tend to have a much longer useful life than carbide burs. This selection represents the most popular shapes in veterinary dentistry.

Friction Grip Diamond Burs

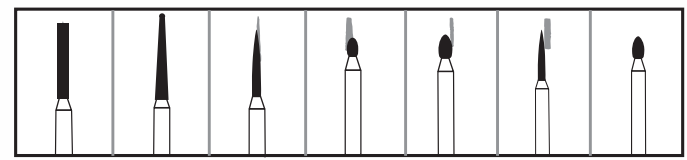

- DTP7127C - Neodiamond burs, Flat End Cylinder (Coarse)
- DTP7611TF - (Tight Occlusion Bur) Trimming & Finishing / Dimension: 0.10 mm Dia, TF 12 Flutes
- DTP835-014 - (Flat End Coarse Cylindrical) Feline PK / Dimension: 1.4mm Head Dia., 4.0mm Head Length
- DTP837-018 - (Flat End Coarse Cylindrical Canine PK / Dimension: 1.8 mm Head Dia., 8.0 mm Head Length

From Left to Right

- DTP1610M - Neodiamond Burs, Round End (Medium)
- DTP1610C - Neodiamond Burs, Round End Taper (Coarse)
- DTP1610F - Neodiamond Burs, Round End Taper (Fine)
- DTP5128C - Neodiamond Burs, Flame (Coarse)
- DTP5128M - Neodiamond Burs, Flame (Medium)
- DTP5128F - Neodiamond Burs, Flame (Fine)
- DTP1908C - Neodiamond Burs, Egg (Coarse)
- DTP1908F - Neodiamond Burs, Egg (Fine)
- DTP1923M - Neodiamond Burs, Football (Medium)
- DTP128VF - Neodiamond Burs, Flame (Very Fine)
- DTP390VF - Neodiamond Burs, Egg (Very Fine)
- All Neodiamond Burs - 5 per pack

Additional Burs

RA (Latch Type) Bur - 5 per pack
For use with Contra Angles (Latch Type)

- DTP10036 - #700
- DTP10038 - #701
- DTP10042 - #702
- DTP10059 - #1/2
- DTP10060 - #2
- DTP10064 - #4
- DTP10066 - #6
- DTP10068 - #8
- DTP10040 - #33-1/2
- DTP10067 - #35
- DTP20201 - Dentalaire Starter Bur Pack with 10 assorted RA (Latch Type) Burs

Handpiece Burs

For Low Speed, 40mm - 5 per pack

- DTP10070 - #700
- DTP10071 - #701
- DTP10072 - #702
- DTP10073 - #1/2
- DTP10074 - #2
- DTP10075 - #4
- DTP10076 - #6
- DTP10077 - #8
- DTP10078 - #33-1/2
- DTP10079 - #35

Friction Grip/Surgical Length Burs

Many types of burs are available. The cross-cut fissure bur (699, 700, 701, 701L, 702 is a good all-purpose bur that can be used to section teeth and gain endodontic access. It is also useful as a general purpose bur. The round bur (1/2, 1, 2, 3, 4, 6, 8) is used to gain endodontic access, to prepare cavities and to mark the cutting depth in crown preparation. The inverted-cone bur (33-1/2, 34, 35, 37) is used for undercutting cavity preparation to create a mechanical interlock. The pear-shaped bur (330, 331, 332) is used for root canal access and for undercutting dentin.

Round

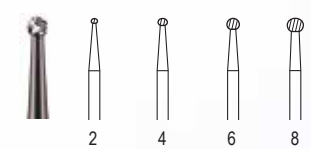

Friction Grip Burs, 16mm

- DTP10046 - Round Bur #1/2
- DTP10047 - Round Bur #1
- DTP10048 - Round Bur #2
- DTP10050 - Round Bur #3
- DTP10052 - Round Bur #4
- DTP10054 - Round Bur #6
- DTP10056 - Round Bur #8
- DTP10201 - 10 assorted burs with bur block, includes #6, #8, #330, #557, #558, #699, #700, #701, #702, #332

Pear

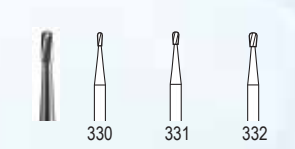

- DTP10017 - Pear Shape #330
- DTP10018 - Pear Shape #331
- DTP10020 - Pear Shape #332

Straight Fissure Crosscut

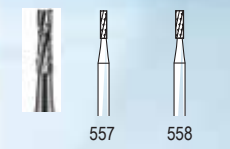

- DTP10021 - Cross-Cut Fissure #557
- DTP10019 - Cross-Cut Fissure #558

Friction Grip/Surgical Length Burs

Inverted Cone



- DTP10033 - Cone Shape #33-1/2
- DTP10034 - Cone Shape #34
- DTP10035 - Cone Shape #35
- DTP10037 - Cone Shape #37

Tapered Fissure Crosscut

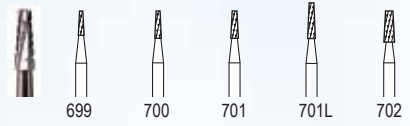

- DTP10025 - Cross-Cut #699
- DTP10026 - Cross-Cut #700
- DTP10028 - Cross-Cut #701
- DTP10030 - Cross-Cut #701L
- DTP10032 - Cross-Cut #702

Replacement Tips

For Ultrasonic, Megasonic, and all Air Scalers
Useful in big dogs with big teeth

- DTP00245 – Satelec #1S (Universal)
- DTP00246 – Satelec #2 (Voluminous)
- DTP00247 – Satelec #10P (Shallow Pocket Tip)
- DTP00248 – Satelec #3 (Voluminous, Stains)
- DTP10861 – Perio Tip (New style air scaler)
- DTP10862 – Universal Tip (New Style air scaler)
- DTP10863 – Sickle Tip (New Style air scaler)
- DTP10880 – Cavitron Insert 25K (Fine)
- DTP10881 – Cavitron Insert 30K (Fine)
- DTP10879 – Cavitron Insert 25K (Wide)
- DTP100UN – Megasonic Tip (Universal)
- DTP100FL – Megasonic Tip (Flat)
- DTP100PR – Megasonic Tip (Perio)
- DTP100CT – Catheter Tip f/Megasonic
- DTP100TW – Tip Wrench f/Megasonic
- DTP10876 – Star Titan Universal Tip
- DTP10877 – Star Titan Perio Tip
- DTP10878 – Star Titan Rebuild Kit
- DTP10882 – Sonix, Lynx, Airstream (Universal)
- DTP10883 – Sonix, Lynx, Airstream (Perio)
- DTP10884 – Sonix, Lynx, Airstream (Sickle)
- DTP10870 – Tip for Air Scaler (Sickle)
- DTP10875 – Tip for Air Scaler (Universal)
- DTP00576 – Replacement Spindle for Air Scaler
- DTP10872 – Tip for Air Scaler (Perio)
- DTP10885 – Sonus V Stack with Nosecone
- DTP10888 – Universal Tip to Sonus V Stack
- DTP10887 – Flat Tip to Sonus V Stack
- DTP00784 – Amdent Universal Tip #39
- DTP00785 – Amdent Flat Tip #32
- DTP00786 – Amdent Special / Perio Tip #33
- DTP00788 – Amdent Endo File Holder Tip 90°
- DTP00791 – Amdent Interproximal #37
- DTP00793 – Amdent Catheter Tip
- DTP00794 – Amdent Scaling tip #31 (Removal Gross Calculus)
- DTP00796 – Amdent Scaling tip #PE-41PS (Super Slim, Perio)
- DTPTIPPAK – Set of 5 Amdent tips, 31, 42, 33, 37, 39
- DTPFOO065 – Satelec Apical Surg. Tip AS3D
- DTPFOO254 – Satelec Original Tip
- DTPFOO245 – Satelec 1S Tip
- DTPFOO246 – Satelec #1 Universal Tip
- DTPFOO247 – Satelec #2 Vol. Calcu. Tip
- DTPFOO248 – Satelec Tip #3
- DTPFOO253 – Satelec Shal. Pock. Tip 10P
- DTPFOO366 – Satelec Tip # PH1

Surgical Length Burs, 25mm

Useful in big dogs with big teeth

- DTPFGSL2 - Surgical Length FG. #2
- DTPFGSL4 - Surgical Length FG. #4
- DTPFGSL557 - Surgical Length FG. #557
- DTPFGSL558 - Surgical Length FG. #558
- DTPFGSL6 - Surgical Length FG. #6
- DTPFGSL701 - Surgical Length FG. #701
- DTPFGSL702 - Surgical Length FG. #702
- DTPFGSL8 - Surgical Length FG. #8

Check Your Piezo Tips!

Simply hold your tip up to the corresponding illustration - if yours is worn down more than 2mm it is time to replace it!

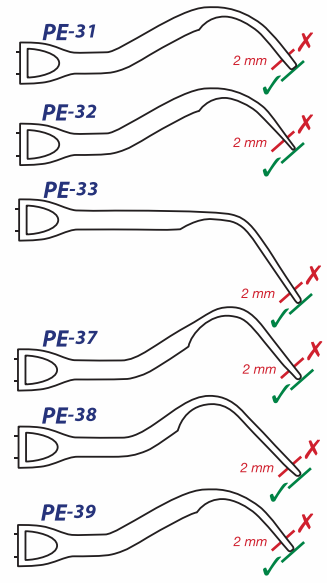

Did you know that every mm of tip wear reduces efficiency by 25%?

Cavitron Inserts

DTP10880 - Fine 25K



DTP10881 - Fine 30K



DTP10879 - Wide 25K



Scalers



DTP00795 - Newtron Booster

Inclined front panel for better visibility
- Easier access to settings and handpiece
Exclusive handpiece holder
- Reduced risk of handpiece falling
- Removable and autoclavable silicone
Flat surfaces and sleek design
- Totally watertight and hygienic for simple cleaning
Connects to the water supply via Quick-Connect
The Newtron Booster contains Newtron Slim Handpiece, #1, #2, 10P tips, three blue dynamometric wrenches, autoclavable plastic box, US power supply

PROUDLY BROUGHT TO YOU BY:



Consider the benefits

- Linear tip vibration provides more comfort for your patients
- Vibration-free handpiece provides increased tactile sensation
- No heat build-up in handpiece means less water required and your patients stay dryer
- “Cruise Control System™” provides maximum performance more power and control for a variety of applications
- Patented color coded scaling system
- Two year warranty



DTP00797 - Newtron P5 with LED

Flat glass surface and uncluttered design
- Effortless interaction with the practitioner
- Easier access to settings and handpiece
- Totally watertight and hygienic for simple cleaning
Removable power knob
- Adjustable, autoclavable handpiece holder
Connects to the water supply via Quick-Connect
The Newtron P5 with LED comes with Newtron Slim Handpiece with white LED ring, #1, #2, 10P tips, two blue dynamometric wrenches, one green dynamometric wrench, autoclavable plastic box, US power supply

Other Satelec tips available, call for details



DTPFOO246 - Satelec #1 Universal Tip
Treating simple cases and gross supra-gingival scaling. Tangential orientation to the tooth surface.



DTPFOO247 - Satelec #2 Voluminous Calculus
Removing voluminous supra-gingival deposits, flat end to apply to the surface of the teeth.



DTPFOO253 - Satelec #10P Shallow Pockets
Fine tip designed for scaling shallow pockets, greater irrigation than other tips.

DTPFOO248 - (Not Pictured) Satelec #3 Stains / Voluminous
Removing stains and voluminous supra-gingival deposits, flat end to apply to the surface of the teeth.

Scalers

DTP00776 - Scalex 880 Piezo Ultrasonic Scaler
Features:

- Self-tuning and load adjusting for maximum smooth operation
- Extremely gentle on patients
- Runs cool and quiet
- Compact size with slim lightweight handpiece
- Includes 3 autoclavable tips, 2 universal and 1 flat

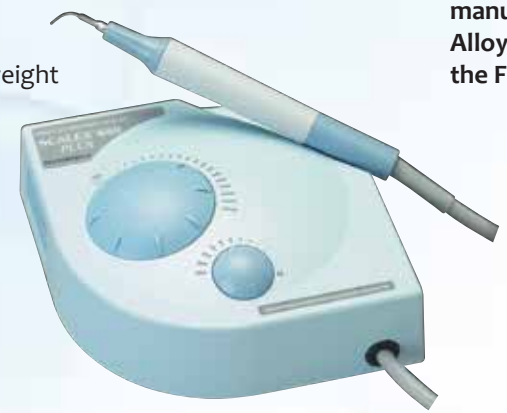

Replacement Tips -
DTP00781 - Universal
DTP00782 - Flat
DTP00783 - Special/Perio
One Year Warranty

DTP00798 - P7 Ultrasonic Scaler – Scaler / Perio / Endo
DTP00799 - P7 LED Ultrasonic Scaler – Scaler / Perio / Endo

Patented Hand Piece is manufactured with Aluminum Alloy Material – the First in the World!



- Both units include:
- Unit w/ footpedal
 - Handpiece
 - Scaling Tips (5)
 - T1, T2, T4, T5 Scaling Tips
 - T3 Perio
 - E1 (and 4 files)
 - Endodontic function
 - Torque Wrench
 - Endo Chuch
 - Endo Wrench
 - Power Adapter
 - Water Line (water source not included)

Micro Motor
DTP00780 - Rotex 782E Micro Motor

- 30,000 RPM Slowspeed Handpiece
- Prophy Angle with Prophy Paste & Cups
- Contra Angles with Cutting Burs
- Variable Speed Foot Control
- One Year Warranty



RAM 1000 Micro Motor

Micro-torque control circuitry design that provides smooth constant power at all speeds. It has 5 sealed ball bearings (3 in front nose cone). It can be operated by hand or foot and goes from a crawl to 35,000 RPM. Also will go forward and in reverse. Comes complete with a prophy angle, prophy paste and cups, a contra angle with burs and a diamond disc cutting wheel. ONE YEAR WARRANTY. Made in the USA.

DTP103RM - Complete Prophy & Restorative Unit



DTP104RM - RAM Micro-Cad Rechargeable Polisher



Combination Scaler / Electric Polisher

PROUDLY BROUGHT TO YOU BY:



Cocoon® Spray

One second's scaling = 10 meters' scraping...
Imagine doing that by hand!

DTP2484V-K - Dentalaire Combination Scaler / Electric Polisher
Cocoon with Spray brings high performance compact equipment in veterinary dentistry.
Performance: 40,000 RPM

The Cocoon includes the innovative addition of a water spray micro motor hand piece that disperses water onto the tooth for cooling from an external water source (water source not included). Water is available from both hand pieces.

Equipped with the piezo electric technology developed by Satelec this unit guarantees you:

- Rapidity: the mechanical elimination of deposits is assisted by cavitation
- Optimal control of the instrument; contrary to its ultrasonic competitors, the module generates perfectly controlled power (feedback effect) gives the Cocoon much greater power than pneumatic scalers
- Wide choice of ultrasonic tips

The Cocoon with spray with its electric micro motor module and external spray provides the following benefits:

- It's self-regulated speed, compatible with diamond tipped or tungsten carbide (40,000 at the end of the micro motor shaft)
- It's high torque to ensure maximum precision of the preparation (automatically controlled by the feedback system)
- It's spray cooling to avoid tissue necrosis and to remove debris
- The Intramatic coupling of the micro motor is compatible with the majority of rotary instruments on the market ("E" type)
- Furthermore, the micro motor can be used for minor orthopedic surgery (cats) or for polishing teeth after scaling.

Included with your Cocoon:

- DTPF00246 - #1 Scaling Tip (Universal)
- DTPF00247 - #2 Scaling Tip (Flat)
- DTPF0025 - #10P Scaling Tip (Shallow pockets)
- DA2500ECA - Latch Type Contra Angle
- DA2500SNC - Straight Nose Cone
- DA10955 - Prophy Angle
- DTP00720 - Prophy Cups
- DTPF00406 - Tip Wrench



DTP00773 - Water Bottle



My cat and dog are healthy because their teeth are healthy!

- Q. How much horsepower do I need to run a Dentalaire unit?**
A. 1/2 horsepower per dental station, which will run the high speed handpieces and low speed handpieces for hours of dental procedures.
- Q. Do the dental stations come with high speed and low speed handpieces?**
A. Yes, they do. We also include start-up supplies for polishing, a starter bur pack, and handpiece lubricant with all of our dental stations.
- Q. Can Dentalaire customize a dental station to my certain needs or specifications?**
A. Yes, we can. For example, we can add suction, a one horsepower motor, fiberoptics in the highspeed handpiece, ultrasonic scaling units, or almost anything else you desire. Since we are the manufacturer, we are happy to customize your unit to your desired individual specifications.
- Q. What are the advantages of the Dentalaire compressor?**
A. Dentalaire compressors are extremely quiet, odorless and are legendary for their workhorse construction.
- Q. What is the warranty on the Dentalaire dental station?**
A. They come with a one or two year warranty depending on model. The only exception is the piezo ultrasonic scaler which comes with a two year warranty.
- Q. Is Air Scaling the same as Piezo Ultrasonic Scaling?**
A. No, it is not. Air Scaling is "sonic" scaling rather than "ultrasonic", operating at approximately 6,000 cycles per second. Ultrasonic (piezo and cavitron type units) scalers operate at up to 35,000 cycles per second. In general, the ultrasonic scalers are quieter and scratch the tooth surface less. Sonic Scalers are air driven by the compressor and place a large load on the compressor.
- Q. What happens to me if my Dentalaire dental station breaks down 6 months after my warranty has expired?**
A. Please call us at (800) 866-6881 to discuss your problem. Your satisfaction is our main goal. Many times we can trouble shoot over the phone to solve the problem.
- Q. What needs to be done to keep the Dentalaire Dental Station running smoothly?**
A. A. Always Always lubricate high speed handpieces. Check instructions for lubricating low speed handpieces. Some low speed handpieces do not need lubrication. If in doubt, ALWAYS contact Dentalaire Products Technical Support.
B. Use only distilled water in dental station to prevent build up in the lines and handpieces.
C. Follow compressor maintenance chart. This takes only one minute per day.
D. Make sure oil level is visible in the glass eye (at least half way up) on the back side of the compressor.
Please note: Oil level is too high when you do not see any air bubble. If this happens, do not run compressor and call Dentalaire.
- Q. What options do clinics usually add to their dental unit?**
A. A. Fiberoptic Illumination in High-Speed Handpiece or Piezo LED. This feature greatly improves your visibility .
B. Adding a piezo scaler to any two handpiece unit
C. Standard straight tubing or curled tubing that stretches.
- Q. Does Dentalaire repair other companies equipment and handpieces?**
A. Yes we do.
- Q. Can I use other companies' handpieces in my new Dentalaire station?**
A. Yes in most cases. Any standard "four-hole" handpiece will work with your Dentalaire station.
- Q. My bur got stuck in my high speed handpiece. How can that happen?**
A. By not putting the bur all the way in. This can cause small nicks in the shaft of the bur, causing it to become stuck. The tolerances for the shaft of the burs are very close, and even microscopic nicks in the shafts will not allow the burs to slide freely.
- Q. How long does the light stay on in the high speed fiberoptic handpiece?**
A. About 12 seconds after stopping the handpiece.
- Q. Can I get suction in a Dentalaire system? Do I need to have suction?**
A. Yes, you can get suction in a Dentalaire station. This requires a dual head compressor or special order with any other unit.
- Q. When would I need a bigger compressor for my Dentalaire Dental Station?**
A. If you desire suction or want to use a sonic scaling handpiece as your main method of scaling, you should consider a one horsepower SilentAire compressor. Suction and sonic scalers place a much larger load on a dental compressor.

Product #	Item	Hi Speed	Low Speed	Water & Air	Piezo Scaler	Pneu. Arm Lift	Mobile Cart	Counter Top	Wall Mount	Table Mount	Fiber-optics	P. Button Bur	Compressor
DTP00494	Dentalaire II	X	X	X			X					X	
DTP00495	Dentalaire II	X	X	X			X					X	X
DTP00500	Dentalaire II	X	X	X				X				X	X
DTP00504	Dentalaire III	X	X	X	X			X				X	X
DTP00509	Ultimate Vet Dental Station	X	X	X	X		X				X	X	X
DTP00510	Prestige	X	X	X	X	X	X				X	X	
DTP00511	Prestige	X	X	X	X	X	X				X	X	X
DTP00550	Cabinet to Countertop Unit												
DTP00600	Two Handpiece	X	X	X					X			X	
DTP00601	Two Handpiece	X	X	X					X			X	X
DTP00607	Dentalaire Basic	X	X	X						X		X	
DTP00608	Dentalaire Basic	X	X	X						X		X	X
DTP00777 Upgrade any Dentalaire II System to Piezo Scaler													
DTP00470 Upgrade any system to Fiber Optic push button High Speed													

For information on our specialized Diplomate Series of Dental Stations, please refer to page 39 and 42.

To order a Dentalaire unit with an Oil Free Compressor, please add -OL to the end of the part number (example Prestige with Oil Free Compressor is DTP00511-OL)

**Or Custom Build
your own Dental Station!**

All Countertop Dental Systems (and Table Systems) come with a 1000ml. water bottle, which mounts on the inside of the compressor. The Mobile, Wall Mount, and Table Mount Systems come with a quick connect 1500ml. water bottle. Distilled water is RECOMMENDED! The Prestige and Ultimate Dental Systems have (2) 2 liter water bottles. Distilled water is recommended!

All Dental Stations include a FREE Dental Vet Package: 10 Friction Grip High Speed Burs, Stainless Steel Prophy Angle, Vetcare Prophy Paste (250gm jar), Prophy Cups (box of 144).



VSSI Table

Two Superior Companies Partner to Bring You Excellence in Complete Dental Wet Tables
(Professional installation recommended)



Laminate Wet Table with 2 Doors

- 60" laminate with 5" deep tub
- Custom built for DentaIaire Diplomate System
- Gooseneck swivel faucet, 72" sprayer hose
- Recessed PVC coated rack system
 - Rack fits on lip inside tub for a flush work surface
- Strainer assembly
- Laminate Cabinet:
 - High-pressure laminate exterior
 - White, custom color or DentaIaire blue
 - 3/4" construction
 - Corners are glued and screwed
 - Medical grade handles & pulls
 - Melamine interior

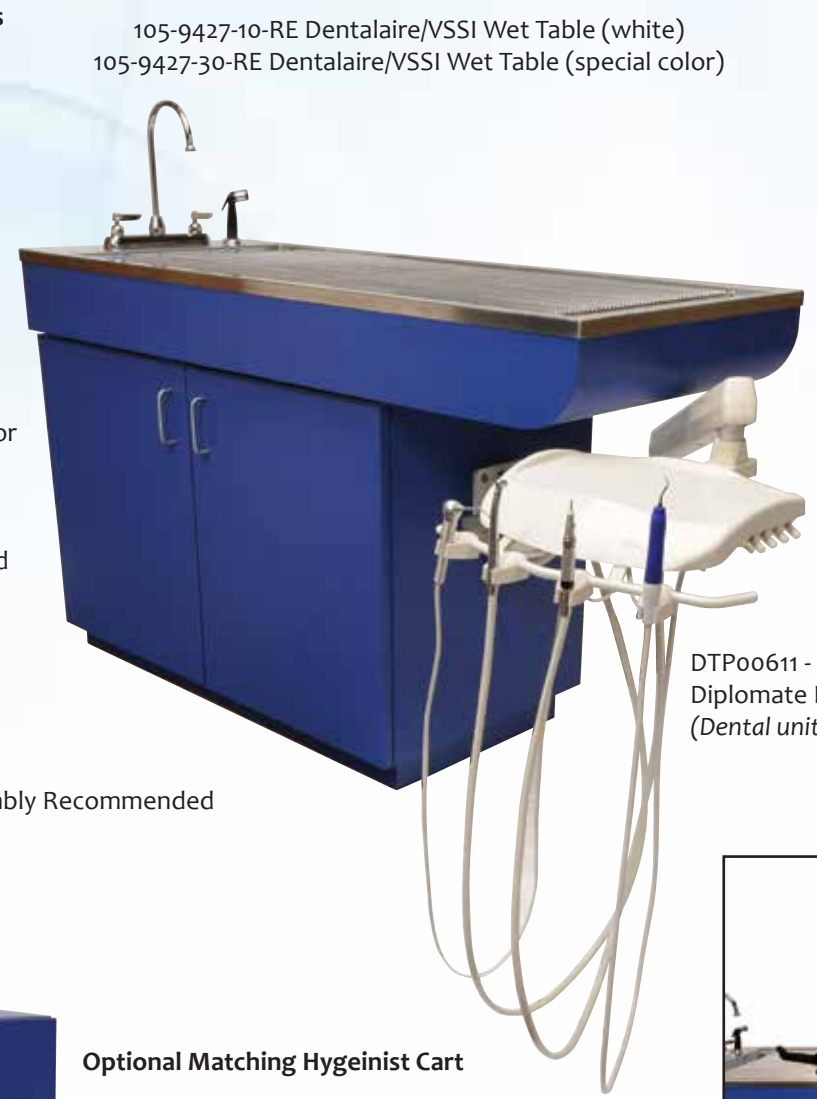

105-9427-10-RE DentaIaire/VSSI Wet Table (white)
105-9427-30-RE DentaIaire/VSSI Wet Table (special color)



Diplomate Dental System

- 3 HP automatic select
- Lighted high speed handpiece, slow speed, LED piezo scaler
- 3-way syringe with quick change autoclavable tip
- Asepsis flex arm system with pneumatic brake
- Hard plumbed water hook up kit included
- Complete dental starter kit
- Optional water bottle system available
- Oil free compressor included

DTP00611 - DentaIaire Diplomate Dental System
(Dental unit only, does not include table)

Professional Assembly Recommended



Optional Matching Hygeinist Cart

- The Perfect Companion to your New Dental Station
- 3 drawers with casters

101-7920-10 Hygeinist Cart (white)
101-7920-30 Hygeinist Cart (special color)



For assistance in ordering your new Dental Station, please contact your favorite DentaIaire or VSSI Distributor. Table and Hygeinist cabinet will be shipped directly from VSSI, Dental Station will be shipped from DentaIaire.

Mobile Cart Dental Systems



Prestige Dental Station features:
DTP00511 – Prestige Dental Station

- Internal Storage
- Telescopic pneumatic arm height adjustment from 37.5" down to 28"
- Fiber optic push button high speed hand piece
- Low speed hand piece
- Piezo LED lighted scaler
- Three way syringe
- Variable speed foot control
- 2 - 2 liter bottle system
- Quick disconnect pressurized water connection
- Silent air compressor 1/2 HP
 - Internal powder-coated air tank
 - Dual filtration system for the cleanest air
- Dental Vet Package: 10 Friction Grip High Speed Burs, SS Prophy Angle, Vetcare Prophy Paste (250gm jar), Prophy Cups (box of 144) and Once a Day Spray
- 2 year warranty excluding handpieces
- 38.5" wide x 30.5" deep

*Silentaire Oil-less Compressor Available
Two Year Warranty



The Most Easily Maintained Dental Station in the World. Simply lift the top for internal storage. Replaceable parts are accessed under the large internal storage tray.

- Asepsis design with controls located on side panel
- Large work area with internal storage
- High speed fiber optic handpiece with push button turbine
- Light weight, low speed, lube free handpiece
- Built in Piezo Scaler with LED light source
- Three way syringe (air, water, and spray)
- Dual filtration system, cleanest air
- Virtually soundless compressor
- Built in dual water system
- Telescopic height adjustment



- NEW! Scaler LED Light**
- Added to light weight Piezo Scaler Handpiece
 - Assists in cleaning hard to see places
 - Easy on the eyes

Mobile Cart Dental Systems



Ultimate Dental Station features:
DTP00509 – Ultimate Dental Station

- Telescopic height adjustment from 39” down to 27”
- Fiber optic push button high speed handpiece
- Low speed hand piece
- Piezo scaler
- Three way syringe
- Variable speed foot control
- 2 - 2 liter water bottle system
- Silent air compressor 1/2 HP
Internal powder-coated air tank
Dual filtration system for the cleanest air
- Dental Vet Package: 10 Friction Grip High Speed Burs, SS Prophy Angle, Vetcare Prophy Paste (250gm jar), Prophy Cups (box of 144) and Once a Day Spray
- 1 year warranty excluding handpieces
- 22” wide x 24” deep

*Silentaire Oil-less Compressor Available
One Year Warranty

Dentalaire II Station features:
DTP00495 – Dentalaire II

- High speed push button hand piece
- Low speed hand piece
- Water and air
- One year warranty



There are many models to choose from and can be custom designed.

Please refer to equipment comparison chart on page 36 to see which features and options certain dental systems have. Thank you!

- DTP00494 - Dentalaire II Mobile Cart without compressor
- DTP00495 - Dentalaire II Mobile Cart with compressor
- DTP00510 - Dentalaire III Mobile Cart with Piezo Scaling, without compressor
- DTP00509 - Dentalaire III Mobile Cart/Ultimate Dental Station with compressor
- DTP11310 - Compressor oil, 22oz. (should be changed yearly)

All Dental Stations include a FREE Dental Vet Package: 10 Friction Grip High Speed Burs, Stainless Steel Prophy Angle, Vetcare Prophy Paste (250gm jar), Prophy Cups (box of 144) and Once a Day Spray.

Counter Top Systems



DTP00500

Dentalaire II Station features:
DTP00500 – Dentalaire II

- High speed push button hand piece
- Low speed hand piece
- Water and air
- One year warranty



DTP00504

Dentalaire III Station features:
DTP00504 – Dentalaire III

- High speed push button hand piece
- Low speed hand piece
- Piezo Scaler
- Water and air
- One year warranty

There are many models to choose from and can be custom designed.

Please refer to equipment comparison chart on page 36 to see which features and options certain dental systems have. Thank you!

- DTP11310 - Compressor oil, 22oz. (should be changed yearly)
- DTP00500 - Countertop Two Hand Piece System with compressor
- DTP00504 - Countertop Three Hand Piece System with compressor
- DTP00503 - Three Hand Piece System with Cabinet

All Dental Stations include a FREE Dental Vet Package: 10 Friction Grip High Speed Burs, Stainless Steel Prophy Angle, Vetcare Prophy Paste (250gm jar), Prophy Cups (box of 144) and Once a Day Spray.



DTPJ-6300 - Diplomate
Wall Mount Whip Style



DTPJ-3300 - Diplomate
Wall Mount Standard Style

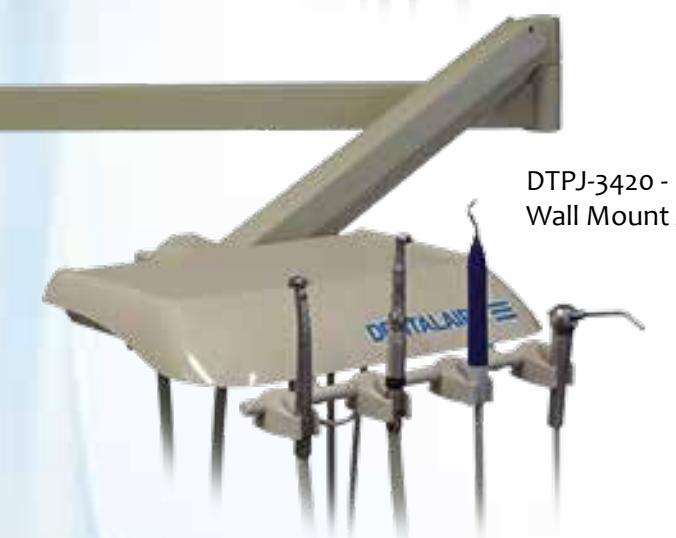

DTPJ-3420 - Diplomate
Wall Mount Asepsis Style

- 3HP Automatic top post mount
- High speed handpiece, slow speed handpiece, piezo scaler
- Side mounted control adjustments
- 3-way syringe with quick change Autoclavable tip
- Master ON/OFF toggle with indicator
- Pressure adjustment for each handpiece
- Asepsis flex arm system with pneumatic brake, 52: reach, 27: vertical travel
- Silentaire compressor DA50-9D included
- Soft touch variable speed foot control
- Vet Pak (Start up supplies)
- 7' umbilical tubing
- Utility center assembly 14" x 9" x 5 3/8"
- Wall mount plate included
- Can be used with hard plumbed water system (filtration needed)
- Optional lighted high speed handpiece
- Optional lighted scaler handpiece
- Optional separate water bottle option available - A110-052
- Optional 1.5 DA 2 Oil Free Compressor (multiple stations) or DA1/24/57 (single station)
- Nitrogen or compressor air driven
- Professional installation recommended (contact Dentalaire)
- 2 Year Warranty



Wall Mount Dental Systems



Two Handpiece System (pictured):

- High Speed Push Button Handpiece
- Low Speed Handpiece
- Water and Air

Three Handpiece System (not pictured):

- High Speed Push Button Handpiece
- Low Speed Handpiece
- Piezo Scaler
- Water and Air

DTP00600 - Wall Mounted Two Handpiece System without Compressor

DTP00601 - Wall Mounted Two Handpiece System with Compressor

All Dental Stations have a One Year Warranty and include a FREE Dental Vet Package that contains: 10 Friction Grip High Speed Burs, Stainless Steel Prophy Angle, Petcare Prophy Paste (250gm jar), Prophy Cups (box of 144).

**We specialize in Custom Dental Suites,
contact us for additional information!**



Table Mount Dental Systems



DTP00607 - Table Mounted Two Handpiece System without Compressor

DTP00608 - Table Mounted Two Handpiece System with Compressor

Available in a Silencing Cabinet! Silent Oil Free Compressor Rated at only 52 decibels.

- H.P.: 1.5
- Voltage: 110/60, 230/50, 230/60
- Output: 6.7 CFM / 190 LPM
- Max Pressure: 120 PSI
- Operating Pressure: 90-120 PSI
- Noise Level: 72 decibels
- Tank Size: 13 gallons
- Dimensions: 18 x 26 x 35
- Weight: 119 lbs.
- Shipping Dimensions: 33 x 28 x 39
- Shipping Weight: 132 lbs.



DA2/50/37
Compressor Only

Silentaire Technology

DA2 Oil Free
With Desiccant Dryer

- FEATURES
- Oil Free
 - Automatic
 - Quiet Operation with Silencing Cabinet
 - Teflon Lubrication
 - Desiccant Dryer
 - Aftercooler
 - Clean, Dry Air

- Internally Painted Tank to Prevent Rust
- Regulator with Built in Moisture Trap
- Thermally Protected
- Line Pressure Gauge
- Tank Pressure Gauge
- 2 Year Warranty

DA2/50/379
Compressor with Cabinet



Silencing Cabinet

- Noise Level: 52 decibels
- Tank Size: 13 Gallons
- Dimensions: 29 x 23 x 32
- Weight: 207 lbs.
- Shipping Dimensions: 32 x 28 x 39
- Shipping Weight: 253 lbs.



Dual User Silentaire Compressor

- Overall dimensions: 19" high, 27.5" wide, 13" deep
- Tank: 6.5 gallons
- Capacity: 1 HP, 110V Motor delivers 4.3 CFM @ 80 PSI
- Weight: 100 lbs.



DA50-9D

Silentaire Compressor

- Overall dimensions: 19" high, 8" wide, 18" deep
- Tank: 2 gallons
- Capacity: 1/2 HP, 110V Motor delivers 4.1 CFM @ 80 PSI
- Weight: 60 lbs.

Silentaire Oilless Compressor
Now Available! 5/8 HP

Oil Free Compressor

- Overall dimensions 17.5 x 9 x 15.5
- Tank .93 Gal
- Capacity: 3.5 Lt tank delivers 2.5 CFM @ 100 PSI 115 V / 50 – 60 Hz or 220 V / 50 – 60 Hz



DA50-9D3

Dentalaire DTX Digital Dental Imaging System Cost / Benefit Analysis

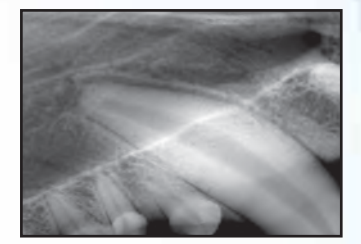

Why Invest in a Digital Dental Imaging System?

Some of the reasons are detailed below. The benefit analysis is based on a single doctor practice seeing five dental patients a week, and taking 20 dental films per week. This is a very conservative estimate, which results in 960 dental films per year. Most veterinarians implementing improved dental care into their practices easily average double that number of films. Multi-doctor practices enjoy multiple savings.

Item	Savings
1. Cost of Film	\$960/yr
2. Cost of Chemistry	\$336/yr
3. Employee time to develop, rinse, handle, and catalog the films. This is estimated in human dentistry to be \$2-5 per film. If this seems high, consider the total costs for your employees, which is much higher than their hourly wage. We use the lowest figure.	\$1,920/yr
4. Filing system for films. Simple envelopes or dental film mounts.	\$40-300/yr
5. Fewer re-takes. Conservatively, you will need to re-take your films around 10% of the time for improper technique. These re-takes use film, chemistry, and more employee time.	\$330/yr

Total hard cost savings per doctor per year \$3,646/yr

There are also some "soft cost savings" that are more difficult to quantitate, yet result in undeniable positive financial effects.

1. Chemical tracking and disposal costs are a normal part of human dentistry. This will inevitably become a factor for veterinarians in the future. Registration fees, compliance paperwork and hazardous chemical disposal fees are all likely, and are not required for digital systems.
2. X-Rays are easily exported for emailing or printing. X-Rays can be emailed to patient owner for viewing and discussion.
3. No clinical downtime while you wait for a film to be developed. This can save many hours per year.
4. DTX Software is installed for you, via the Internet. You save time and hassles.
5. DTX Software can be integrated with many practice management software.
6. DTX Digital Dental System is more than a dental radiography program. It serves as an integrated image management suite, which allows you to gather all digital information into one place, where it can be easily accessed. Digital radiographs, digital photos, MRI's, CT's, scanned radiographs, ultrasound images and clips, endoscopic pictures and clips, etc. can all be gathered in one easy-to-access area. From there, they can be viewed, printed, and shown to clients in the exam room.

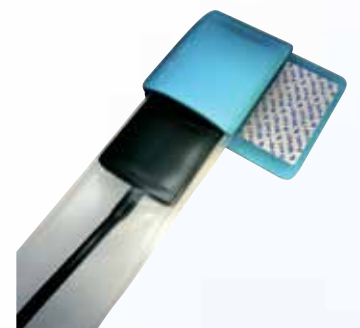

DTP61611 - WrapEaze Sensor Wrap Comfor Cushion - Box of 50
A fully adjustable, "All-In-One" seamless barrier sleeve, comfort cushion, and positioning aid that fits all brands of sensors!

DTP61610 - Plastic Sensor Sleeves - Box of 500 (not pictured)





DTP60807



DTP70002



DTP61302

Dentalaire DTX Digital System

- DTP61302 - DTX Dental Imaging System, Mobile Style Complete with X-Ray generator, #2 Sensor, Laptop with pre-loaded DTX software, laptop tray. (Mobile generator assembly required)
- DTP60807 - DTX Dental Imaging System, Wall Mounted Style Complete with Wall Mounted X-Ray generator, #2 Sensor, Laptop with pre-loaded DTX software, laptop tray. (Wall mount generator installation not included)
- DTP7000 - DTX Dental Imaging System with #1 and #2 size Sensor, includes sensor, software, support
- DTP70001 - DTX Dental Imaging System with #1 Sensor, includes sensor, software, support
- DTP70002 - DTX Dental Imaging System with #2 Sensor, includes sensor, software, support
- DTP70008 - DTX Size #1 Sensor only
- DTP70009 - DTX Size #2 Sensor only
- DTP700010 - DTX Size #1 Sensor, warranty replacement
- DTP700011 - DTX Size #2 Sensor, warranty replacement
- DTP700012 - DTX Software License
- DTP700015 - DTX Software Upgrade, upgrade from XVLITE Software to Dentalaire DTX software
- DTP700016 - USB Active Extension Cable, 16ft
- DTP700017 - DTX Dental Camera with LED Ring Flash
- DTP700018 - In clinic Dental Radiology Positioning Training, instruction completed by Veterinary Dental Technician Specialist
- LAPTOP - DTX Laptop
- DTP61303 - Laptop Tray Only



Sadie: Damaged root and bone surrounding distal root. Radiograph can also be used as extraction guide.

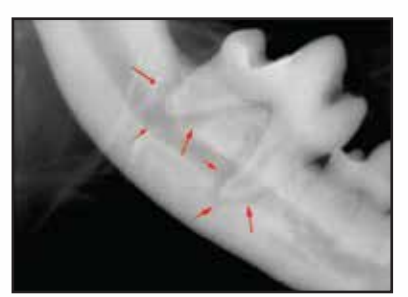

Ellie: Large area of bone loss around both roots of a dead tooth that "appeared" normal. Owners claimed Ellie acted like a new animal post recovery.

DTP700017 - Specialized Dental Camera with LED Ring flash - includes Mouth Mirror



The optical 4X zoom lens offers a high performance, large aperture of F2.0. Six LED Macro Lights around the circumference of the lens barrel allows for brighter, uniform macro illumination. High-resolution 3.0-inch color LCD monitor captures full HD video in widescreen 1080p resolution.

DENTALAIRE DTX

Dental Imaging System



- Embedded High speed USB 2.0 interface for direct connection to the PC
- State of the art image quality achieved with CSI scintillator and fiber optic plate (FOP)
- Highly reliable design with patented cable output and watertight housing
- 2 year sensor warranty
- The best DICOM software capabilities in the market
- Our software features canine, feline and equine tooth charts with species and breed selections
- Integration with all major practice management applications
- Unmatched, unlimited support for life

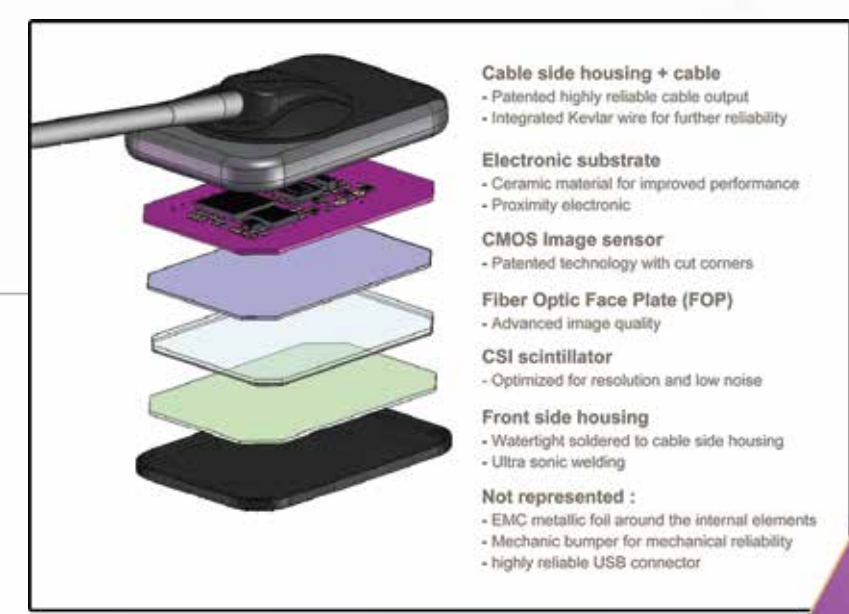



Technical Specifications

Description	Size 2 Sensor	Size 1 Sensor
External Dimensions (mm)	30.5 x 42.8 x 5.4	24.3 x 36.7 x 5.4
Active Image Area (mm)	26 x 36	20 x 30
Image Pixel Size	19 µm x 19 µm	19 µm x 19 µm
Number of Pixels	2.6 million	1.66 million
Theoretical Resolution	26 lp/mm	26 lp/mm
USB Connector	Hi-Speed USB 2.0	Hi-Speed USB 2.0
Cable length	10 feet	10 feet
Warranty	2 years	2 years



The Dentalaire DTX System is designed to work on any Windows based computer, although a more robust computer will provide faster performance.

Please call us if you have specific questions related to your computers performance.

Use Windows XP at your own risk as support from Microsoft has ended.

Corix® Pro 70 Vet Dental X-Ray

Wall mount mounting plate dimensions: 9.75" x 18"

• 70 KVp Tubehead Assures high quality, sharp, well defined images in intra-oral radiography

• Long reach
• Double Positioning Arm moves effortlessly and folds compactly when not in use. Ease of positioning and drift free stability.
DTP60800 - Corix Pro 70 Wall Mount

• Standard, Short or Long Extension Arm to fit all your requirements.

Corix® Pro 70 Wall mount, also for side-by-side operatory stations.

Corix® Pro 70 Mobile Stand, on a sturdy and stable rolling stand. DTP61300 - Corix Pro 70 Mobile Stand

Corix Pro 70 Vet Dental X-Ray is compatible with any digital dental system.

Base Dimensions: L 28" x W 32.25" x H 71.5"



70 KVp Tubehead

The 70KVp-8mA Tubehead with a small focal spot, low energy filter and beam limiting device assures outstanding sharpness and maximum details in intra-oral radiography. Positioning is made easier with an angle indicator on both sides of the unit. Lead shields and critical components are oversized to provide more years of safe and trouble free operation.

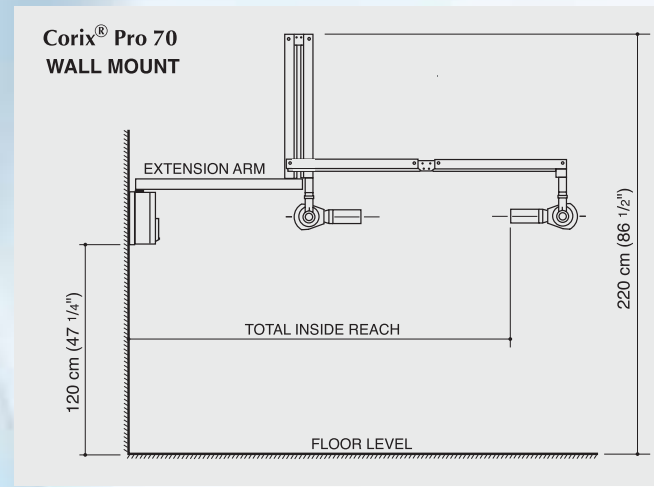

Long Reach Double Positioning Arm

The long reach scissors arm moves effortlessly through a wide area, yet folds compactly when not in use. Ease of positioning and drift free stability.

Standard, Short or Long Extension Arm (Wall Mount version)

Designed to fit your requirements:
 Standard Extension Arm provides a total inside reach of 180.6 cm. (71 1/8")
 Short Extension Arm provides a total inside reach of 135.6 cm. (53 3/8")
 Long Extension Arm provides a total inside reach of 190.5 cm. (75")

Corix® Pro 70 is a wall mounted or mobile system

Conditions in your practice will dictate where to perform x-ray examinations. With the Corix Pro 70 you can choose the option that best fits your needs:

Corix® Pro 70 Wall Mount, DTP60800

Wall mounted in the x-ray room or directly in the treatment room, even for side-by-side operator stations.

Corix® Pro 70 Mobile Stand, DTP61300

Mobile stand, to reach separate operator stations on a sturdy and stable rolling stand.

Hand Held Digital Exposure Timer

A new generation of small size, 3 digit remote controller with a 1/100 of a second resolution, fully compatible with the fastest film or a film-less digital imaging system. 9 factory pre-set memories, patient size, film or digital sensor, or manual override if required. Automatic compensation for the main voltage variations. All of above and more in a controller that fits into the palm of your hand. Optional Remote Timer Configuration, should the controller be located outside the operatory.

Technical Features	
RATED LINE VOLTAGE	120V. +/- 10% (109-132 V.a.c.), 50/60 Hz.
POWER CONSUMPTION	1.050 KW max @ 132 V.a.c.
RATED TUBE POTENTIAL	70 KVp +/- 7% (Single phase, self rectifying).
RATED TUBE CURRENT	8 mA +/- 15% @ 120 V.a.c.
EXPOSURE TIME RANGE	0.03 to 3.00 s., in steps of 0.01 s. Plus 9 pre-set exposure times, with automatic main voltage compensation. A pre-heating time of 0.15 s. for loading the x-ray tube is not shown on the display.
MINIMUM FOCAL SPOT TO SKIN DISTANCE	200 mm. (8")
RADIATION LEAKAGE @ 1 m.	Less than 50 mR/h (Technical Factors: 70KVp, 8 mA, 1 s.).
FOCAL SPOT	0.8 x 0.8 mm.
TOTAL FILTRATION	2 mm. Al eq.
NET WEIGHT	Mod. WM (Wall Mount): 28 Kg. Mod. MM (Mobile Stand): 40 Kg.
SHIPPING WEIGHT	Mod. WM (Wall Mount): 33 Kg. Mod. MM (Mobile Stand): 46 Kg.
SHIPPING DIMENSIONS	Mod. WM (Wall Mount): 1 Box, 131 x 52 x 26 cm. Mod. MM (Mobile Mount): 2 Boxes, 111 x 34 x 19 cm., and: 86 x 34 x 33 cm.
<i>Corix Medical Systems® reserves the right to modify the design and specifications without prior notice.</i>	

® Corix, and: Corix Medical Systems, are Registered Trademarks.

1 Year Warranty. Price does not include installation.

DTP00800 - TelereX X-Ray Film developer



- Special CCD & LED technology offers instant viewing of dental X-ray film on a TV or computer monitor.
- View old X-ray film or digitize and archive them to your computer.
- Optional USB Video Grabber enables the TelereX to connect to the computer via the USB port.
- Improves communication between the doctor and patient with enlarged viewing
- Compact and stylish design with spring loaded film tray, only 9.4 x 9.2 x 7.2 cm.
- Special film adapter included for Pedo size X-ray film.
- 100-240V universal voltage, NTSC or PAL available.

DTP10115 - Chairside Darkroom

Convenient, easy to use, cost effective.

Complete with:

- X-Ray Fixer
- Developer
- Film Clips (set of 3)



DTP10500 - Mini X-Ray Viewer



DTP10501 - Replacement Bulb

- DTP10439 - Kodak X-Ray Film #0, box of 100 (DF-54)
- DTP10440 - Wolf X-Ray Film #2, box of 100 (D-Speed)
- DTP10441 - Kodak X-Ray Film #2, box of 150 (DF-58)
- DTP10455 - Kodak X-Ray Film #4, box of 25 (DF-50)
- DTP10431 - Film Carriers (for film #2), Pack of 25
- DTP10432 - Film Carriers (for film #4), Pack of 25
- DTP10460 - X-Ray Film Clips, Pack of 3, (useful in film developing)
- DTP10430 - X-Ray Film Holder (Autoclavable)
- DTP10433 - X-Ray Film Mounts #2, 100 (for film storage)
- DTP10434 - X-Ray Film Mounts #4, 25 (for film storage)
- DTP10484 - X-Ray Developer (quart)
- DTP10486 - X-Ray Fixer (quart)
- DTP10485 - X-Ray Fixer/Developer (set of 2)
- DTP10442 - Size 1 X-Ray Film (100) Kodak

- DTP01503 - Sitzman Shield - Small 12 x 12 X-ray Shield
- DTP01514 - Sitzman Shield - Large 12 x18 X-ray Shield

While The Sitzman Shield is engineered to attenuate the direct beam of a dental X-ray machine, it is intended to be used as an aid in decreasing exposure from scatter radiation. This product is not a substitute for proper training in radiation safety.

Miscellaneous Products

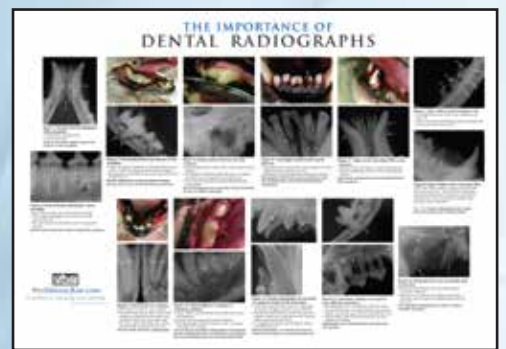

DTP61000 – Vet Dental Rad X-Ray Poster Educational Poster - Great for Waiting Rooms and Patient Exam Rooms

DTP62500 – Woodward/Neimiec Radiology DVD Educational Instructional DVD presented by Dr. Tony Woodward and Dr. Brook Niemiec, Radiology Simplified. Includes dental radiology positioning instruction.



NEED HELP?

- DTP61011 - A Color Handbook Small Animal Dental, Oral & Maxillofacial Disease, Soft Cover
- DTP61011 - Veterinary Endodontics, Soft Cover, Brook A. Niemiec DVM
- DTP61012 - Dental Extractions Made Easier Brook A. Niemiec DVM
- DTP61001 - Dental Radiology Simplified Brook A. Niemiec DVM
- DTP61013 - Veterinary Restorative Dentistry for the General Practitioner

Sterident Vacuum System



DA8009PD

Steri-dent PORTO-DENT II Mobile Evacuation Unit. Efficient, Adjustable motor speed can evacuate indefinitely at the rate of 75 cfm, or can be adjusted. Compact (13" x 16" x 26") Easy Maintenance, Non-corrosive collection canister cleans easily and is equipped with an automatic overflow shut-off. Motor: One year warranty.

AVS Vacuum System



AVS self contained air powered Vacuum System. For optimal use, Dual User Silent Air Compressor should be ordered.

Part Number: "AVS"

Highly Flexible Light Pipe- Twice as long as conventional pipes

DTP44810

1 LED - 3x the typical light output; pinpoint accuracy; true tissue color rendition

Touchless On/Off



Mounting Plate to attach as shown DTP44811



Miscellaneous Products

Electrosurgery Unit



DTP00805

- All cord lengths are specifically designed to allow ease of use for intra oral surgery – 12 FT
- User friendly control panel
- Safely designed electronics
- Minimal scar tissue
- Minor to high demand dental surgery
- Cut, COG 1 & COG 2 mode
- 10 level power setting
- 7 pc. Various standard electrodes

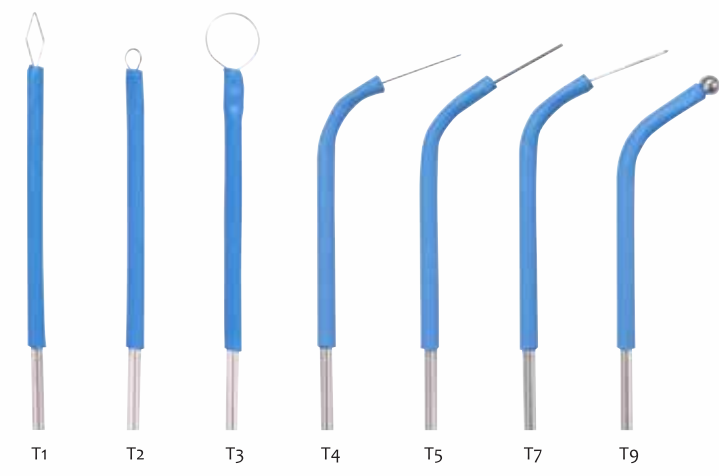

- DTP0001-012 - T1 Diamond Shape Electrode
- DTP0001-022 - T2 Small Loop Electrode
- DTP0001-032 - T3 Large Loop Electrode
- DTP0001-042 - T4 Fine Wire Electrode
- DTP0001-052 - T5 heavy Wire Electrode
- DTP0001-072 - T7 Fine Oval Loop Electrode
- DTP0001-092 - T9 Heavy Ball Electrode

DTP42252 - Disposable IV Stabilizer Pack of 10



DTP00-C20-B - Citrisil Tablets



Optical Glass Binocular Magnifier



- DTP90608 - DA-2 (1-1/2 x at 20")
- DTP90609 - DA-3 (1-3/4 x at 14")
- DTP90610 - DA-4 (2 x at 10")
- DTP90612 - Light for Visor

- Leaves both hands free
- Optical polished (not plastic) glass lens
- Tilts up when not in use
- Adjusts to all head sizes
- Leather comfort band
- Can be worn over prescription or safety glasses

The DentaLaire Prestige Dental Station

Add Prestige to your Dental Suite!



The Most Easily Maintained Dental Station in the World. Simply lift the top for internal storage. Replaceable parts are accessed under the large internal storage tray.

- Asepsis design with controls located on side panel
- Large work area with internal storage
- High speed fiber optic handpiece with push button turbine
- Light weight, low speed, lube free handpiece
- Built in Piezo Scaler with LED light source
- Three way syringe (air, water, and spray)
- Dual filtration system, cleanest air
- Virtually soundless compressor
- Built in dual water system
- Telescopic height adjustment



NEW! Scaler LED Light

- Added to light weight Piezo Scaler Handpiece
- Assists in cleaning hard to see places
- Easy on the eyes

Miscellaneous Products



DTP62200 - Canine Skull
DTP62300 - Feline Skull



For Dental Educational & Demonstration

Transparent and firm smooth plastic models with removable replaceable teeth. Graphically shows important anatomical relationships.
DTP101VMD - Canine
DTP101VMDCO - Canine w/Gingiva
DTP102VMC - Feline
DTP102VMCCO - Feline w/Gingiva
DTP103VMDC - Combo Canine and Feline
DTP105VMC - Feline Mouth Model With X-ray Teeth
DTP105VMD - Canine Mouth Model With X-ray Teeth



DA100SL - Once-a-Day Handpiece Lubricant
8oz. can

Dentalaire Introduces Private Line of Prophy Products!

Same Ingredients as Major Manufacturers, Less Cost!



DA100PL - Pen Lube - 1/4oz. Handpiece lubricant with fine needle tip applicator

A healthy mouth enhances the life of your patients. Dentalaire Products strongly believes in and supports continuing education by sponsoring several CE events throughout the year.

Many veterinarians and technicians benefit by attending additional veterinary CE education functions. Several training centers are available in the continental USA. These highly specialized training centers are organized and taught by Diplomates of the American Veterinary Dental Society. Interested parties should contact the facility directly.



The Colorado Pet Dental Training Ctr
Tony M Woodward DVM, Dipl AVDC,
5520 N Nevada Ave
Colorado Springs CO 80918
www.vetdentalclasses.com
719-536-9949



San Diego Vet Dental Training Center
Brook Niemiec DVM, Dipl AVDC, EVDC, FAVD
5775 Chesapeake Ct
San Diego, CA 92123
www.vetdentaltraining.com
858-279-2108



Animal Dental Training Center
Ira Luskin DVM, Dipl AVDC, EVDC
Baltimore MD 21237
www.AnimalDentalCenter.com
410-828-1001



Veterinary Dental Education Center
Brett Beckman DVM, FAVD, Dipl AVDC, DAAPM
2225 Waymont Ct Suite 111
Lake Mary FL 32746
www.veterinarydentistry.net
941-276-9141



VDENT – (Veterinary Dental Education, Networking and Training)
Fox Valley Veterinary Dentistry and Surgery
Cindy Charlier DVM, Dipl AVDC
Courses held at Northern IL University
5555 Trillium Blvd
Hoffman Estates IL 60195
www.veterinarydentistryce.com
847-525-8642